

WILDEN®

Expert Solutions for Critical Applications

BRAND
Portfolio



Where Innovation Flows

wildenpump.com

FIT BOLTED METAL PUMPS | ADVANCED™ BOLTED PLASTIC PUMPS
ORIGINAL™ CLAMPED METAL PUMPS | ORIGINAL™ CLAMPED PLASTIC PUMPS
SANIFLO™ SANITARY AND HYGIENIC PUMPS | HIGH-PRESSURE PUMPS

a  company

PSG[®], a Dover company and the global leader in positive displacement pump and supporting technologies, delivers value-added pumps and systems that serve customers requiring the safe and efficient transfer of critical and valuable materials. PSG features world-class pump brands and has multiple facilities on four continents (North America, Europe, Australia and Asia) that are ISO certified. We are passionately committed to innovative technologies that will positively impact the world. Our priority is providing the market expertise you need by delivering tomorrow's innovative fluid and material-transfer solutions today.

Where Innovation

POSITIVE DISPLACEMENT PUMPS

RECIPROCATING	ROTARY
Almatec [®] AODD	Abaque [™] PERISTALTIC
Neptune [™] METERING	Blackmer [®] SLIDING VANE, SCREW
Wilden [®] AODD	EnviroGear [®] INTERNAL GEAR
Quattroflow [™] QUATERNARY DIAPHRAGM	Mouvex [®] ECCENTRIC DISC
Finder [®] PISTON, PLUNGER	RedScrew [™] SCREW
	Ebsray [®] VANE, GEAR
	Finder [®] SCREW

PUMPS & SYSTEMS TECHNOLOGIES

CENTRIFUGAL	REGEN TURBINE	MIXERS	COMPRESSORS	SYSTEMS
System One [®]	Ebsray [®]	Neptune [™]	Blackmer [®]	Fluid Dynamics [™]
Griswold [™]		Quattroflow [™]	Mouvex [®]	Neptune [™]
Finder [®]				Mouvex [®]
			VACUUM	Finder [®]
			Finder [®] LIQUID RING	

WILDEN®

Who
We Are

Wilden® Pump and Engineering LLC, part of PSG®, Oakbrook Terrace, IL, USA, is the leading global provider of air-operated double-diaphragm (AODD) pump technology. Since 1955, Wilden has been solving the toughest pumping applications in the world through excellence in research and development, deep market knowledge and unmatched customer service. PSG features a broad array of leading pump technologies as well as world-class facilities in the United States, Germany, China, India and France. The leading infrastructure, knowledge base and intellectual capital of PSG truly make it the power behind fluid transfer.



Grand Terrace, CA (USA) – Wilden is based in Grand Terrace, CA, USA, where the company was conceived in Jim Wilden’s backyard. Today, Wilden occupies more than 170,000 square feet (15,793 square meters), incorporating a world-class manufacturing facility. Wilden also has a fully equipped R&D laboratory, clean room, test facility, QC department, CAD department, injection molding center and customer satisfaction department. Our elite distributor network ensures that you will have access to the latest pump technologies and fluid transfer services available when you need them. To find a distributor closest to you, go to wildendistributor.com.

The Power Behind Your Process – It all began with one man’s innovation; an inspiration that inspired a revolution and created an entire industry over five decades ago. Wilden founder Jim Wilden was working as a foreman when a large water pipe ruptured several feet below ground at a steel factory. Amid the chaos of a flooded shop floor, Mr. Wilden’s vision of a unique but reliable utilitarian pump that would pump water, slurry or any finely-divided substance was born. His will and determination to perfect a pump tough enough to handle jobs other pumps couldn’t, such as creating a pump that could meet the stringent demands of the mining and heavy construction industries, led to the invention of the air-operated double-diaphragm pump.

The company that began in a walnut grove now spans over 160 countries with over 180 distributors worldwide. Mr. Wilden’s legacy of product innovation and a commitment to excellence lives on in everything Wilden does today. With leading-edge products, innovative solutions and the same determination Mr. Wilden used to build this company, Wilden is proud to truly be the power behind your process.



Flows

MARKETS SERVED

ENERGY

Wilden is leading the way in energy efficiency in storage terminals, biofuels and solar cell manufacturing. Wilden pumps play a vital role as transfer points from one mode of transportation to another and as safe, secure storage locations until product transfer is needed. Wilden is also committed to helping build a clean energy economy through the use of biofuels.

Typical Applications Handled:

- Raw crude oil
- Chemicals
- Caustics
- Ethanol
- Biodiesel
- Gases
- Crude oil
- Refined petroleum products
- Solvents
- Solar cell manufacturing
- Petroleum
- Lube oils
- Gasoline
- Diesel fuel

PROCESS

Wilden is a recognized leader in the process industries as you can find Wilden pumps in many of the top chemical, food and beverage and pharmaceutical plants around the world.

Typical Applications Handled:

- Acids
- Solvents
- General chemicals
- Pulp and paper
- Low-solvent coating
- Caustics
- Soap and detergents
- Paints, inks and coatings
- Cosmetics
- Solvent-less coating
- Alcohols

HYGIENIC

Wilden offers a wide range of hygienic and biopharmaceutical pumps for various food, beverage, dairy, personal care and pharmaceutical applications. When it comes to safety, performance and gentle transfer solutions, trust Wilden: the evolution of clean.

Typical Applications Handled:

- Personal care
- Confectionary
- Fruits and vegetables
- Poultry, fish and meat
- Filling/batching
- Dairy
- Pharmaceutical/biopharm
- Sauces, purees and beverages
- High purity product transfer
- Ingredient receiving/unloading

WATER/WASTEWATER

Wilden plays a critical role in handling and transferring fluids used in municipal and industrial water and wastewater plants.

Typical Applications Handled:

- Wastewater systems
- Rehabilitation systems
- Distribution
- Metal fabrication
- Potable water systems
- Water treatment supply
- Collection and disposal





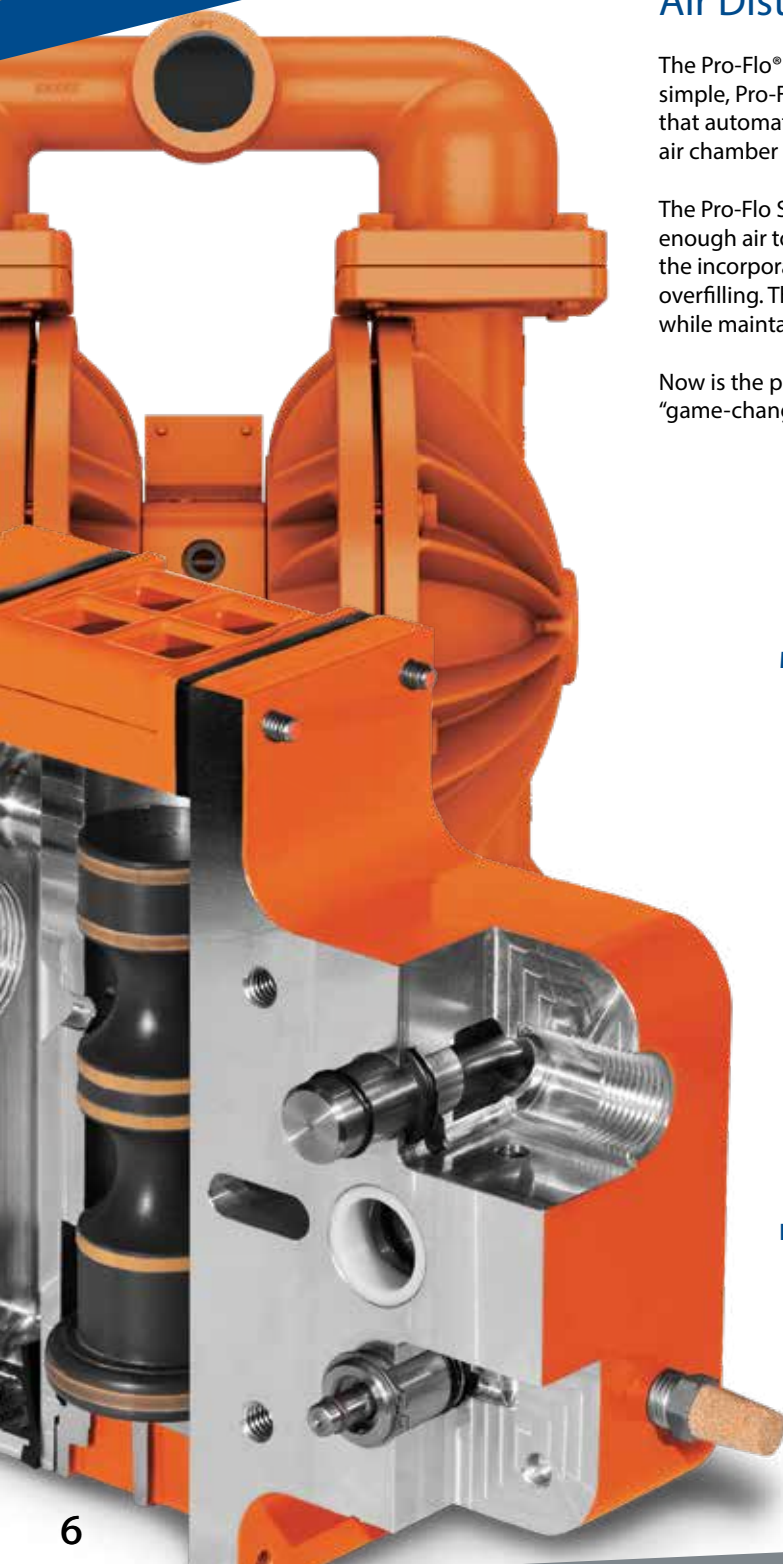

STATE-OF-THE-ART

Air Distribution Systems

The Pro-Flo® SHIFT is the new standard for AODD pumps. The innovative, yet simple, Pro-Flo SHIFT Air Distribution System (ADS) features an “air control spool” that automatically optimizes air consumption and eliminates overcharging of the air chamber with no reduction in flow rate.

The Pro-Flo SHIFT’s revolutionary ADS design meters the air flow, allowing for just enough air to keep the pumping process operational. This is accomplished through the incorporation of an air control spool that automatically meters the air to prevent overfilling. The results are a reduction in air consumption and operational costs while maintaining maximum operational efficiency and volumetric consistency.

Now is the perfect time to shift your thinking in AODD pump performance with the “game-changing” Pro-Flo SHIFT; put us to the test today.



Market Position:

- Cost efficient: 50% less expensive than an electronically-actuated ADS
- Faster return on investment
- Robust design for harsh operating conditions
- Metered air consumption for less product waste
- Creates the highest performance ratio
- Superior flow rate
- Superior anti-freezing
- Single-point exhaust option
- Lube-free operation
- Reduced maintenance costs
- ON/OFF reliability
- Environmental sensitivity
- Reduced energy consumption
- Lower carbon footprint
- ATEX-compatible for use in explosive atmospheres

Application Traits:

- Greater yield per SCFM of air used
- Wider application range
- Repeatable, predictable performance
- Less product waste
- Max. Mean Time Between Repair (MTBR)
- Increased application range/compatibility
- Minimum training required
- No special skill set needed for maintenance or operation

Features:

- Simple and durable pump design
- Simple components
- Faster, easier setup time
- Plug-N-Play operation
- No electricity needed
- Precise flow rate at start-up
- Non-stalling unbalanced spool

Availability:

- 22 mm (1")
- 38 mm (1-1/2")
- 51 mm (2")
- 76 mm (3")
- 102 mm (4")

SHIFTING PERFORMANCE TO A WHOLE NEW LEVEL.



Market Position:

- Variable control (discharge flow rates and air consumption)
- Superior flow rate
- Superior anti-freezing
- Single-point exhaust option
- Lube-free operation
- ON/OFF reliability
- ATEX models available

Features:

- Efficiency Management System (EMS™)
- Metal and plastic material options
- Non-stalling unbalanced spool
- Simple and durable design

Application Traits:

- Maximize performance and efficiency
- Process applications
- Max. Mean Time Between Repair (MTBR)

Availability:

- 13 mm (1/2")
- 25 mm (1")



Market Position:

- Anti-freezing
- ON/OFF reliability
- Longest-lasting wear parts
- Lube-free operation

Features:

- Plastic center block
- Non-stalling unbalanced spool
- Simple and durable design

Application Traits:

- Maximum reliability
- Process applications
- Max. Mean Time Between Repairs (MTBR)

Availability:

- 6 mm (1/4"), 13 mm (1/2"), 25 mm (1"), 38 mm (1-1/2"), 51 mm (2"), 76 mm (3")*



Market Position:

- Direct electrical interface
- Superior ON/OFF reliability
- Reduced systems costs
- Lube-free operation

Features:

- Externally controlled
- Various voltage options
- Nema 4, Nema 7 or ATEX
- Simple installation

Application Traits:

- System automation
- 4-20 mA pH adjusting
- Batching applications
- OEM accounts

Availability:

- 6 mm (1/4"), 13 mm (1/2"), 25 mm (1")

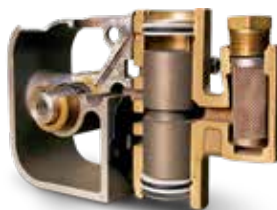

Market Position:

- Low initial cost
- Largest installed base
- Proven technology
- Originated the AODD pump

Features:

- Metal air distribution system
- Durable
- Fewest replaceable parts
- Ease of maintenance

Application Traits:

- Utilitarian-type applications
- Robust design
- Single-point exhaust option
- Portable

Availability:

- 13 mm (1/2"), 25 mm (1"), 38 mm (1-1/2"), 51 mm (2"), 76 mm (3")

*Advanced™ plastic model only



Progressive Diaphragm Technology

Thermoplastic Elastomer (TPE)

- Polyurethane is an outstanding general-purpose diaphragm for nonaggressive chemical applications such as water, wastewater and seawater. It provides excellent flex life, abrasion resistance and durability at an economical price.
- Wil-Flex™ provides a low-cost alternative to PTFE with a cost comparable to neoprene. Made of Santoprene™, Wil-Flex is ideal for use with acidic and caustic fluids such as sodium hydroxide, sulfuric or hydrochloric acids. Exhibiting excellent flex life, abrasion resistance, temperature range and durability, it is widely used in the chemical process, food, pharmaceutical and wastewater industries. Versions of Wil-Flex are available that comply with FDA 21 CFR 177 standards for food and beverage applications.
- Saniflex™ is an excellent material for food processing applications. Made of Hytrel®, it exhibits good flex life and excellent abrasion resistance. Hytrel also offers superior sealing or seal energizing due to its low compression set characteristics. Saniflex versions are available that comply with FDA 21 CFR 177 standards.
- Geolast® exhibits enhanced oil-resistance and low oil swell making it ideal for petroleum industry applications. Equivalent to nitrile (Buna-N), Geolast provides moderate flex life and good abrasion resistance over a wide temperature range at a lower cost than fabric-reinforced Buna-N.



Polytetrafluoroethylene (PTFE) Elastomers

- Because it is one of the most chemically inert compounds available, PTFE can be used with an extremely wide range of fluids. Also known as Teflon®, PTFE is excellent for highly aggressive fluids such as aromatic or chlorinated hydrocarbons, acids, caustics, ketones and acetates. Its properties provide excellent flex life and moderate abrasion resistance. In addition, PTFE complies with FDA 21 CFR 177 and USP Class VI standards for food, beverage and pharmaceutical applications. Because PTFE is non-elastic, a backup diaphragm of a different material must be used to provide flexibility and memory. Material options for backup diaphragms are Neoprene, Saniflex and high temperature Buna-N.



Elastomer Temperature Limits:

Rubber	Neoprene	-18° to 93°C [0° to 200°F]
	Buna-N	-12° to 82°C [10° to 180°F]
	EPDM	-51° to 138°C [-60° to 280°F]
	Viton®	-40 to 177°C [-40 to 350°F]
Thermoplastic (TPE)	Polyurethane	-12° to 66°C [10° to 150°F]
	Wil-Flex	-40° to 107°C [-40° to 225°F]
	Saniflex	-29° to 104°C [-20° to 220°F]
	Geolast	-40° to 82°C [-40° to 180°F]
PTFE	PTFE	4° to 104°C [40° to 220°F]

CAUTION: Maximum temperature limits are based upon mechanical stress only. Certain chemicals will significantly reduce maximum safe operating temperatures. Please verify the chemical resistance limitations of elastomers and all other pump components prior to pump installation. The Wilden online Chemical Guide and a Wilden distributor should be consulted for specifics in elastomer selection.



Rubber Elastomers

- Neoprene is an exceptional general-purpose, low-cost diaphragm. Perfect for nonaggressive chemical applications such as water-based slurries, well water or seawater, it provides good flex life and abrasion resistance.
- Buna-N provides excellent performance in applications involving petroleum/oil-based fluids such as leaded gasoline, fuel oils, kerosene, turpentine and motor oils. In wide use throughout the fuel-processing industry, Buna-N is also referred to as nitrile and provides moderate flex life and moderate abrasion resistance. For food and beverage applications, versions are available that comply with FDA 21 CFR 177 standards.
- EPDM is an excellent material for extremely cold temperatures and is an economical alternative when pumping dilute acids or caustics. EPDM diaphragms are in use in the manufacturing, food, pharmaceutical and paint/coatings industries. The material exhibits good flex life and moderate abrasion resistance, and it is available in versions that comply with FDA 21 CFR 177 standards. EPDM is also a good choice where statically dissipative materials are required.
- Viton is excellent for extremely hot temperatures and provides exceptional performance with aggressive fluids such as aromatic/chlorinated hydrocarbons and strong, aggressive acids. Viton is often the only diaphragm material suitable for applications where harsh chemicals are used because of its high temperature limit and chemical resiliency. It provides moderate flex life and moderate abrasion resistance.



Ultra -Flex™ Diaphragm Technology

- Guaranteed longer life – If longer life is not experienced, Wilden will send you a new set of Ultra-Flex™ diaphragms free of charge.
- Convolute shape, altered fabric placement and unique hardware work together to decrease the unit loading on the diaphragm and distribute stress.
- Material availability: Neoprene, Buna-N, EPDM, Viton.

Visit WildenDiaphragms.com for more information on Genuine Wilden Diaphragms and to download the Wilden Chemical Compatibility Guide.

Genuine **WILDEN**
Accept Nothing Less

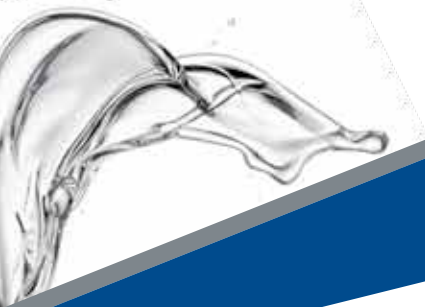

TECHNOLOGY: AIR-OPERATED DOUBLE-DIAPHRAGM

FIT Bolted Metal & Advanced™ Bolted Plastic AODD Pumps

Wilden revolutionary bolted pumps are specifically designed for maximum performance and efficiency. The bolted configuration delivers maximum process fluid containment over traditional clamp-banded designs, while the redesigned liquid path reduces internal friction to maximize output and efficiency. A variety of elastomer options including PTFE are available to meet abrasion, temperature and chemical compatibility concerns. A variety of connection options and specialized air distribution systems (ADS) are available to meet your specific application requirements. Pumps are offered in aluminum, stainless steel, cast iron, ductile iron and Alloy C, as well as unpigmented polypropylene, PVDF, PTFE and PFA.

PS830 FIT Aluminum



P220 FIT Stainless Steel



Applications:

- Mining
- Oil and gas
- Paints and inks
- Plating and finishing
- Pulp and paper
- Semiconductor
- Waste treatment
- Solvents
- Acids
- Caustics
- High viscosity
- High pressure
- Large solids
- Abrasive media
- Hazardous and flammable liquids
- Clean room fluids
- Flammable liquids

Features and Benefits:

- Bolted construction for maximum containment
- ADS: Pro-Flo® SHIFT, Pro-Flo X™, Pro-Flo® or Accu-Flo™ technology
- Higher flow rates
- Lube-free operation
- Higher yields
- Increased pump output
- Reduced air consumption
- Reduced internal friction
- Energy efficient
- Largest chemical compatibilities
- Lower operational costs and downtime
- Longest Mean Time Between Repair (MTBR)

Technical Data:

- Material Availability: Aluminum, Ductile Iron, Cast Iron, Stainless Steel, Alloy C, Polypropylene, PTFE, PFA and PVDF
- Size Availability: 6 mm (1/4") to 76 mm (3")
- Liquid Port Options: BSPT (NPT) (1-1/2", 2" and 3" only), ANSI and DIN
- Elastomer Temperatures to 177°C (350°F)
- Elastomer Options: Buna-N, Neoprene, EPDM, Viton®, Wil-Flex™, Saniflex™, Polyurethane, PTFE and Geolast®

Performance Data:

- Max. flow: 1030 lpm (272 gpm)
- Max. suction lift: 9.7 m (31.8') wet, 7.4 m (24.4') dry
- Max. solids size: 12.7 mm (1/2")

P800 Advanced Plastic

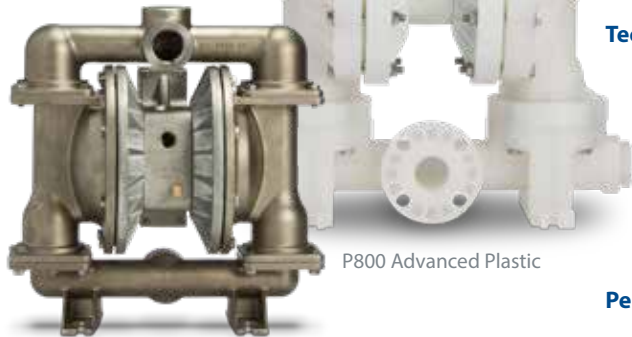

PS420 FIT Stainless Steel

Certifications & Associations:



TECHNOLOGY: AIR-OPERATED DOUBLE-DIAPHRAGM

ORIGINAL™ Clamped Metal & Plastic AODD Pumps

Wilden Original™ pumps ensure reliability without sacrificing ease of maintenance. Original pumps are ideal for various processes and waste applications, as well as construction and mining applications. Wilden pumps have the largest material and elastomer offering in the industry to meet your abrasion, temperature and chemical compatibility challenges. Original pumps are offered in aluminum, stainless steel, ductile iron, as well as unpigmented polypropylene and PVDF. A variety of elastomers, connection options, specialized air distribution systems and configurations, such as the Stallion® site dewatering and mining pump, are all available for your specific application needs.

Applications:

- Ceramics
- Chemical
- Dry powder
- Mining
- Oil and gas
- Paints and coatings
- Plating and finishing
- Pulp and paper
- Sanitary
- Semiconductor
- Waste treatment
- Solvents
- Acids
- Caustics
- High viscosity
- High pressure
- Large solids
- Abrasive media
- Hazardous and flammable liquids
- Clean room fluids

Features and Benefits:

- Portable and submersible
- Large solids passage
- Lube-free operation
- ADS: Pro-Flo® SHIFT, Pro-Flo X™, Pro-Flo®, Accu-Flo™ & Turbo-Flo™ Technology
- Largest chemical compatibilities
- Longest Mean Time Between Repair (MTBR)
- Saves money
- Lower operational costs and downtime
- Intrinsically safe
- Superior anti-freezing
- Ease of maintenance
- Optimized applications
- Energy efficient

Technical Data:

- Material availability: Aluminum, Cast Iron, Ductile Iron, Stainless Steel, Polypropylene, PTFE and PVDF
- Size availability: 6 mm (1/4") to 102 mm (4")
- Multiple liquid port options
- Elastomer temperatures to 177°C (350°F)
- Elastomer options: Buna-N, Neoprene, EPDM, Viton®, Wil-Flex™, Saniflex™, Polyurethane, PTFE and Geolast®

Performance Data:

- Max. flow: 1211 lpm (320 gpm)
- Max. suction lift: 9.5 m (31.2') wet, 7.4 m (24.4') dry
- Max. solids size: 35 mm (1-3/8")

Certifications & Associations:



PS4 Original Stainless Steel



PS15 Stallion

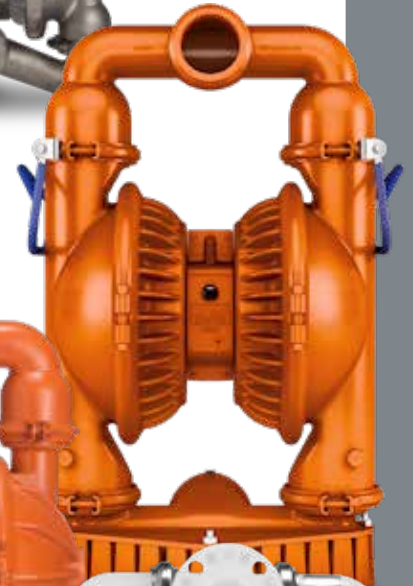

PS8 Original Aluminum



PS8 Original Plastic



P1 Original Stainless Steel



TECHNOLOGY: AIR-OPERATED DOUBLE-DIAPHRAGM
SANIFLO™ AODD Pumps

The Saniflo™ pump line is specifically designed to meet the strict guidelines established for sanitary and hygienic process applications. Wilden Saniflo solutions incorporate a full suite of products like our cast stainless steel pumps made of FDA-grade materials and finished with a high polish. These efficient hygienic pumps feature straight flow-through design, large solids passage and meet stringent 3-A and EHEDG certifications. The Saniflo pump line offers various connections and surface finishes that are clean-in-place (CIP) or clean-out-of-place (COP) for ease of use and maintenance. Wilden is consistently meeting and exceeding industry standards and requirements (FDA, 3-A, EHEDG, Class VI USP, ATEX, 1935/2004/EC) needed to refine your process.

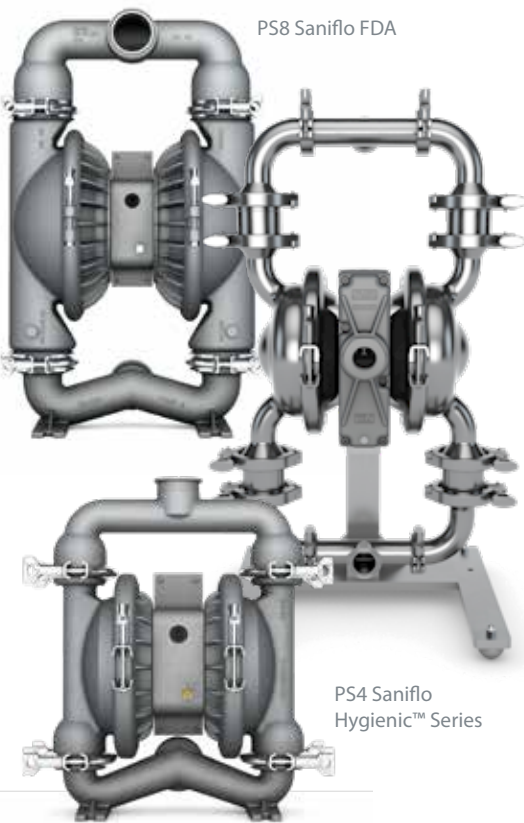

PS8 Saniflo FDA

PS4 Saniflo Hygienic™ Series

PS4 Saniflo FDA

Applications:

- Prepared foods
- Sauces
- Confectionary
- Fruits and vegetables
- Beverages
- Cosmetics
- Meat
- Poultry
- Fish
- Biopharmaceutical
- Pharmaceutical
- Non-sanitary waste
- Waste
- CIP
- High acid
- High sugar
- High-fat food
- Low acid
- Pasteurized and protein-based products
- Product filler feeding
- Batch process metering
- Ingredient unloading
- Pressure-limiting applications
- Handling of shear-sensitive and/or large particulates in thick/thin fluids

Features and Benefits:

- Delicate product handling
- Large solids passage
- Lube-free operation
- ADS: Pro-Flo® SHIFT, Pro-Flo X™, or Accu-Flo™ Technology
- CIP capabilities
- Superior product containment
- High flow rates
- Superior anti-freezing
- Ease of maintenance
- Higher yields
- Minimized product degradation
- Energy efficient

Technical Data:

- Material availability: 316, 316L, or with 304 Stainless Steel fasteners
- Available in 200 Ra finish for the standard 316 Stainless Steel and up to 32 Ra finish for the HS
- Size availability: 13 mm (1/2") to 76 mm (3")
- Tri-clamp style connections
- Elastomer temperatures to 177°C (350°F)
- Elastomer options: Buna-N, EPDM, Viton®, Wil-Flex™, Saniflex™, Polyurethane and PTFE

Performance Data:

- Max. flow: 927 lpm (245 gpm)
- Max. discharge pressure: 8.6 bar (125 psig)
- Max. suction lift: 9.5 m (31.2') wet, 7.6 m (25.0') dry
- Max. solids size (compressible): 76 mm (3")

Certifications & Associations:





WILDEN HS Equalizer® Surge Dampener

The Saniflo Hygienic™ Series (HS) Equalizer® was designed to remove pressure variation on the discharge end of the pump. It has a flow-through design manufactured with existing Wilden pump parts. The HS Equalizer automatically sets and maintains the correct air pressure required to optimize its effectiveness.

Benefits:

- Reduces pipe vibration and shaking
- Protects in-line equipment
- Reduces water hammer
- Absorbs acceleration head
- Lower system maintenance cost
- Suction stabilizer
- Helps prevent leaking at pipe fittings and joints
- Extends and improves pump performance
- Avoids damaging pressure surges
- Wide range of material and elastomer options
- Common parts with Wilden pumps
- Self adjusts to system pressure
- ATEX models available



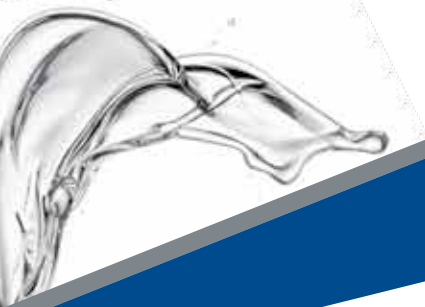

HS430S High-Pressure
Stainless Steel



H800 High-Pressure
Stainless Steel



H220 High-Pressure
Ductile Iron



HS430S High-Pressure
Aluminum

TECHNOLOGY: AIR-OPERATED DOUBLE-DIAPHRAGM

HIGH-Pressure Pumps

Wilden offers a wide range of rugged high-pressure pumps with the latest technological advancements in air distribution systems (ADS). Reliable Wilden high-pressure pumps are able to transfer viscous, solid-laden slurries at high discharge pressures. The Wilden premier simplex and duplex diaphragm and piston pump technologies powerfully deliver pressure up to 20.7 bar (300 psig).

Wilden high-pressure pumps do not require costly external boosters or amplifiers to achieve the pressure output needed for your application. Our high-pressure pumps perform a multitude of duties including filtration, chemical sludge transfer and general industrial applications. Power. Reliability. Flexibility. These are the backbone of Wilden high-pressure pumps.

Applications:

- Filter press feed pump
- Well injection
- Viscous products
- Paint and coatings
- Chemical sludge transfer
- Pressure spraying
- Food processing
- Plating/metal finishing
- Slurry and ceramic slip
- Water/wastewater

Features and Benefits:

- Bolted construction for maximum containment
- Deadhead capability
- Simplex or duplex positive displacement technology
- Lube-free operation
- Maximum containment
- Maintain high discharge pressures
- Operational flexibility
- Energy efficient
- Increased reliability

Technical Data:

- Material availability: Aluminum, Ductile Iron and Stainless Steel
- Sizes: 25 mm (1") to 76 mm (3")
- 25 mm (1") model is available with NPT/BSPT liquid connections
- 38 mm (1-1/2") and 51 mm (2") models are available with ANSI/DIN liquid connections
- Elastomer temperatures to 177°C (350°F)
- Elastomers: Wil-Flex™, Saniflex™, Polyurethane and PTFE
- Max. discharge/inlet air pressure ratio: 3:1

Performance Data:

- Max. flow: 360 lpm (95 gpm)
- Max. discharge pressure: 20.7 bar (300 psig)
- Max. suction lift: 9.0 m (29.5') wet, 3.7 m (12.0') dry
- Max. solids size: 12.7 mm (1/2")

Certifications & Associations:



Accessories

Wilden accessory products add value to your liquid process and expand the application range of Wilden pumps by augmenting the performance and/or utility of the pump. Our electronic controllers automate your Wilden pump for batching and other electronically-controlled dispensing applications. We can also create laminar process flow by eliminating pump pulsation or control the liquid level within a system of process.



WILDEN SD Equalizer®

The Surge Dampener (SD) Equalizer® was designed to remove pressure variation on the discharge end of the pump. It has a flow-through design manufactured with existing Wilden pump parts. The SD Equalizer automatically sets and maintains the correct air pressure required to optimize its effectiveness.



WILDEN Pump Cycle Monitor

The PCMI counts pump cycles by sensing the presence of the air valve piston (Turbo-Flo™) or air valve spool (Pro-Flo®).

- The sensor, located at the air valve and cap, detects the presence of a magnet located at the end of the air valve piston/spool
- The PCMI registers a complete pump cycle when the piston/spool shifts away from the sensor and subsequently returns to the original position
- The PCMI unit has a reset switch located on the face of the PCMI module
- PCMI has the ability to be reset from a remote location

WILDEN Wil-Gard™ III

The Wil-Gard™ detects diaphragm failure at the source: the primary diaphragm, not at the air chamber or the air exhaust as other systems do.



- Sensors are located between the primary and back-up (containment) diaphragms
- When the sensors detect a conductive liquid, an audible alarm, LED and an internal latching relay are activated
- Increase containment, reduce fugitive emissions and reduce downtime with 24-hour pump surveillance
- Power requirement: 110V AC or 220V AC

WILDEN Drum Pump Kit

The inherent features of the Wilden air-operated pump and Accu-Flo™ pump technology allow it to excel as a utilitarian drum pump. Variable speed and pressure capability and the ability to run dry, self prime and deadhead offer you flexibility at a low cost. The Wilden universal drum pump kit enables Wilden 6 mm (1/4") and 13 mm (1/2") pumps to adapt directly to drums for cost-effective, efficient liquid transfer.

- Universal kit for 6 mm (1/4") and 13 mm (1/2") pumps
- Fits 51 mm (2") NPT bungholes
- Tube length can be cut to length
- Variety of materials are available

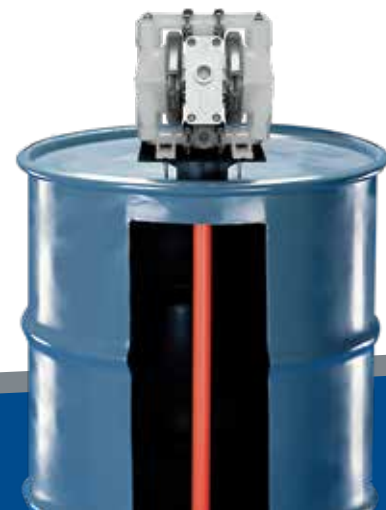

Where Innovation Flows

WILDEN[®]

PSG
22069 Van Buren Street
Grand Terrace, CA 92313-5651 USA
P: +1 (909) 422-1730 • F: +1 (909) 783-3440
wildenpump.com

PSG reserves the right to modify the information and illustrations contained in this document without prior notice. This is a non-contractual document. 10-2017

Authorized PSG Partner: