

# Product Overview



More than just pumps

- ▶ Drum and container pumps
- ▶ Eccentric worm-drive pumps
- ▶ Motors
- ▶ Centrifugal immersion pumps
- ▶ Air-operated diaphragm pumps
- ▶ Flow meters
- ▶ Mixers
- ▶ Accessories
- ▶ Filling units
- ▶ Drum emptying systems
- ▶ Customized all-in solutions
- ▶ Custom made design

# About FLUX

FLUX pump technology – the right solution even for demanding fluids



More than just pumps

## One Brand. One Promise.

The FLUX name has been synonymous with pump technology for more than 60 years. It was the invention of the electric drum pump that sparked it all off. In the meantime of course the technology has become more sophisticated. FLUX company innovations have markedly improved working routines for filling and transferring fluids.

It is often said that medium-sized companies are the engines of progress. We would be pleased if our family business were able to substantiate this claim.

When you choose FLUX you are making a good decision for the long term. With our products we want to assist you to save time and money and by the way – spare your nerves as well. We are therefore delighted when you discuss your requirements with us.

Best wishes,

Klaus Hahn,  
CEO FLUX-GERÄTE GMBH

Pumping, emptying, mixing, filling and metering – when liquids are set in motion the requirements are very diverse. In any event the process must run smoothly. This is what the FLUX brand name stands for. It is recognised across the globe as a byword for quality, for safety and for solutions which are able to fulfil every single demand on a long-term basis.

Smooth-running processes – FLUX not only guarantees this for liquids which are relatively easy to pump but also when the pumping medium is viscous or doesn't flow at all, when it is aggressive or used in processes which are common in the hygiene sector or sectors where there is an explosion hazard. To ensure that the tasks are solved in the best possible way for the customer FLUX has a huge range of expertise to offer. In other words, a lot more than just pumps. From a technical point of view this means a comprehensive product system of pumps, motors, flow meters, accessories and a whole lot more. From the project point of view, "More than just pumps", means accompanying our customers from the first telephone call through to the end solution – and if required beyond that.

This is how FLUX keeps processes moving. Long-term. Simple, complex or custom-made inclusive design assignments: FLUX is prepared for any request and in particular for the fact that our customers need more than just pumps.

### MILESTONES OF PUMP TECHNOLOGY:

**1950**

The first electric drum pump in the world was christened FLUX

**1955**

Foundation of the present day FLUX-GERÄTE GMBH

**1953**

First explosion protected drum pump

**1997**

First explosion protected collector motor constructed





### Quality

From the inventors of the electric drum pump.

- ▶ **Reliability.** In concrete terms: Every minute of downtime is a minute too much. FLUX strives to prevent downtimes in the best way possible.
- ▶ **Long service life.** High-quality technology is one of the most important prerequisites for long-term trouble-free processes.
- ▶ **Made in Germany.** FLUX has its central production location in Maulbronn, Baden-Württemberg.
- ▶ **Awards.** Such as the iF Product Design award which FLUX brand products have won several times underline the unique claim of the FLUX brand.



### Customer focus

Individual solutions for your requirements.

- ▶ **Extensive range of products.** FLUX offers an extensive range of products based on individual components, pre-configured sets and system solutions.
- ▶ **Individual solutions.** For specific requirements FLUX designs and implements special adaptations, custom-made products and complex solutions in-house.
- ▶ **Technology partners.** FLUX consultants are the competent contact for the customer – on the telephone or with the customer on site.
- ▶ **On-call delivery** All popular products are available from the large warehouse at the headquarters in Maulbronn. Local warehouses in different countries supplement capacities where it is economical to do so.
- ▶ **After-sales support.** FLUX guarantees a repair service and supply of replacement parts for a period of up to 20 years following date of purchase.



### Safety

Good to know: It's a FLUX product.

- ▶ **Demanding media.** FLUX technology covers an enormous spectrum of differing media. It goes without saying that FLUX provides maximum safety and reliability for demanding media as well.
- ▶ **Special solutions for individual industries.** Different industries. Different challenges. Whether food industry, pharmaceuticals industry, hygienic or explosion-hazard sectors: The focus always is on product and user safety.
- ▶ **Handling.** Risks which could otherwise occur in operation have already been taken into consideration by FLUX in the design phase. The result: Products which are able to handle complex tasks but which can still be operated with a few simple movements.

2003

First brushless drum pump motor

2014

First brushless battery motor to drive pumps worldwide

2010

Further development of the VISCOFLUX drum emptying systems

and build conform to ATEX Directive 94/9/EC



# Industries, Certificates and Conformities

The right solution for every industry

With its application-based products FLUX has the right solution for every sector of industry. Use our icons as a guide to help you to find the products which are suitable for your industry.



**Chemical**



**Industry**



**Surface technology**



**Paints and lacquers**



**Petrochemicals**



**Foods**



**Cosmetics**



**Pharmaceuticals**



**Water treatment**









**Agriculture**

Certified safety for the most widest range of industries and countries: FLUX products have been developed and certified for use around the world; they comply with the highest demands and safety standards. With FLUX you are always on the safe side everywhere.

All FLUX products conform to pertinent fundamental health & safety regulations of the EC Machinery Directive 2006/42/EC and are therefore CE certified. In addition, FLUX products bear the Eurasian EAC mark issued by the customs union of Russia/Belarus/Kazakhstan.



Furthermore, selected FLUX products are available with the following certificates:

<p><b>For use in the pharmaceutical, foods and cosmetics sector</b> there are pumps with 3A certification, FLUX FOOD pumps conform to EG 1935/2004 and are suitable for contact with food or products available which conform to FDA CFR 21.</p>	  
<p>Dependent on version FLUX motors are available with VDE GS, UL or also CSA test certification are available.</p>	   
<p><b>For use in explosion-hazardous areas</b> FLUX products with explosion protection are available which are built and certified to conform to ATEX Directive 94/9/EC.</p>	

# Table of contents





## Overview







<b>Summary of FLUX pump series</b>	<b>06</b>
<b>Drum and container pumps (series F 300 / F 400)</b>	<b>08</b>
JUNIORFLUX/COMBIFLUX (series F 300)	09
Drum and container pumps (series F 400)	10
<b>Eccentric worm-drive pumps (series F 500)</b>	<b>12</b>
<b>Suitable motors for FLUX pumps series F 300, F 400 and F 500</b>	<b>14</b>
<b>Centrifugal immersion pumps (series F 600 / F 700)</b>	<b>16</b>
<b>Air-operated diaphragm pumps (series FDM / RFM)</b>	<b>18</b>
<b>Flow meters (FMC / FMO / FMT)</b>	<b>20</b>
<b>Mixers</b>	<b>22</b>
<b>Additional products and accessories</b>	<b>23</b>
<b>Filling units</b>	<b>24</b>
<b>Drum emptying systems - VISCOFLUX family</b>	<b>25</b>
<b>Customized all-in solutions</b>	<b>26</b>
<b>Custom made design</b>	<b>27</b>

# Summary of FLUX pump series

Helps you to identify the best pump for your requirements quickly

FLUX Pump Series	Drum pumps series F 300 JUNIORFLUX/COMBIFLUX	Drum and container pumps series F 400	Eccentric worm-drive pumps series F 500	
				
	Page 9	Pages 10 - 11	Pages 12 - 13	
<b>Typical areas of application</b>	Mobile filling of liquid media in small quantities	Mobile filling of liquid media (incl. pre-defined quantities) and/or mixing	Mobile and stationary filling of low through high-viscosity media incl. shear-sensitive media (incl. pre-defined quantities)	
<b>Container/application</b>	Small containers, ~ 200 l drums ~ 1 000 l IBCs	~ 200 l drums ~ 1 000 l IBCs tanks > 1 000 l	~ 200 l drums ~ 1 000 l IBCs tanks > 1 000 l as process pump	
<b>Flow rate max.*</b>	60 l/min	240 l/min	50 l/min	
<b>Head max.*</b>	8.5 mWs	30 mWs	80 mWs	
<b>Viscosity max.*</b>	250 mPas	1 200 mPas	80 000 mPas	
<b>Available certificates</b>				
<b>Special features</b>	▶ Brushless battery motor	▶ Mixing pump ▶ 99.98 % drum emptying ▶ Easily stripped down pump ▶ Also as application-based pump sets	▶ Flow metering via pulse generator possible for version with bearing flange	
<b>Drive options</b>	Electric Optional mains connection or storage battery	Electric or pneumatic	Electric or pneumatic	

\* dependent on pump model, medium and motor





Drum emptying systems VISCOFLUX	Centrifugal immersion pumps series F 600 and F 700	Air-operated diaphragm pumps series FDM and RFM
		
Page 25	Pages 16 - 17	Pages 18 - 19
Mobile and stationary filling of high-viscosity media and media just capable of flowing through to media not capable of flowing (incl. pre-defined quantities)	Stationary and mobile usable process pumps for filling and circulating liquid media in bulk quantities	Process pumps for liquid (incl. abrasive) to high-viscosity media – for low to high flow volumes and high pressure build-up
~ 200 l drums with Ø 560 mm, 571 mm, conical drums	~ 1 000 l IBCs tanks > 1 000 l as process pump	~ 1 000 l IBCs tanks > 1 000 l as process pump
Max. 50 l/min depending on viscosity and flow properties	74 m <sup>3</sup> /h	1 000 l/min
80 mWs	35 mWs	200 mWs
Pasty	2 500 mPas	Just capable of flowing
		
<ul style="list-style-type: none"> <li>▶ Also for conical drums</li> <li>▶ Also for seaworthy container drums</li> <li>▶ Flow metering via bearing flange with pulse generator where required</li> <li>▶ Integration in processes via control unit possible</li> <li>▶ Pump available with left/right operation</li> </ul>	<ul style="list-style-type: none"> <li>▶ E.g. can be used for AdBlue® tank systems</li> </ul>	<ul style="list-style-type: none"> <li>▶ Stroke counter can be integrated</li> <li>▶ Filter press high-pressure pump</li> <li>▶ Cycle control can be integrated</li> <li>▶ Version with flap valve for semi-solids of max. 50 mm</li> </ul>
Electric or pneumatic	Electric	Pneumatic

# Drum and container pumps

For pumping low viscosity fluids out of various containers



FLUX drum and container pumps are suitable for pumping various low-viscosity and also especially aggressive and highly-flammable fluids. The axial-impeller pumps provide a pulsation-free pumping action. Constructed on the modular design, different pumps are able to be driven by the same motor. As a result of their low weight the pumps can be easily carried from container to container. The easy handling of motor and pump keeps changeover times short. Various pumps with and without mechanical seal are available as well as versions for higher pumping heads and mixing pumps. FLUX drum and container pumps are available in versions with explosion protection, with 3A certification as well as FLUX FOOD pumps (Directive (EC) 1935/2004 and FDA CFR 21 compliant). Moreover especially pre-configured pump sets for typical applications are available.

Technical data	   	
	F 300	F 400
<b>For container</b>	Small containers, Hobbocks, ~200 l drums, IBCs	Hobbocks, ~200 l drums, IBCs, tanks
<b>Flow rate max.</b>	60 l/min*	240 l/min*
<b>Head max.</b>	8.5 mWs*	30 mWs*
<b>Viscosity max.</b>	250 mPas*	1 200 mPas*
<b>Motor drive</b>	Electric	Electric/pneumatic



Battery motor FBM-B 3100 – the solution where cables are problematic or not desired.

**Ancillary products and accessories**

A wide range of ancillary products and accessories is available for many different FLUX drum and container pump applications such as e.g.

- ▶ Fume gland
- ▶ Flow meters
- ▶ Hoses
- ▶ Filling units
- ▶ Hand nozzles and other outlet fittings



FLUX FOOD – for application in the food industry.

\* dependent on pump model, medium and motor



# JUNIORFLUX/COMBIFLUX

For filling small quantities



The small drum pumps JUNIORFLUX and COMBIFLUX are particularly suitable for filling comparatively small quantities from containers such as cans up to 200 litre drums. The small diameter of the outer tube makes it possible to pump out of tight openings.

## JUNIORFLUX

For filling small quantities; with fixed commutator motor

### Advantages/characteristics:

- ▶ Motor and pump with fixed connection
- ▶ Available with choice of two types of seal
- ▶ Low overall weight - minimal amount of exertion necessary when changing drums
- ▶ Can pump out of narrow-necked containers

### Examples of media:

- ▶ Acids and lyes
- ▶ Fertiliser solutions
- ▶ Pesticides
- ▶ Cleaning agents
- ▶ Demineralized Water (purified water)

Technical data	
Flow rate max.	57 l/min*
Head max.	8.5 mWs*
Viscosity max.	250 mPas*
Pump material Outer tube	Polypropylene, Polyvinylidene fluo- ride, Stainless steel
Immersion length mm (standard)	500/700/1 000

## COMBIFLUX

For filling small quantities; with removable motor

### Advantages/characteristics:

- ▶ Motor easy to remove
- ▶ Connection of motor to pump via quick-action coupling
- ▶ Driven by a brushless battery motor or electrical commutator motor with mains connection
- ▶ Sealless design
- ▶ Low overall weight minimal - amount of exertion necessary when changing drums

### Examples of media:

- ▶ Acids and lyes
- ▶ Fertiliser solutions
- ▶ Pesticides
- ▶ Cleaning agents
- ▶ Demineralized Water (purified water)

Technical data	
Flow rate max.	60 l/min*
Head max.	8.5 mWs*
Viscosity max.	250 mPas*
Pump material Outer tube	Polypropylene, Polyvinylidene fluo- ride, Stainless steel
Immersion length mm (standard)	500/700/1 000/ 1 200

\* dependent on pump model, medium and motor

# Drum and container pumps

For pumping low viscosity fluids out of various containers

FLUX drum and container pumps are always a "double act" comprising motor and pump. Both components can vary quite flexible. For example different pumps are able to be driven with the same motor. Ideal for reliable pumping of various low-viscosity liquids - incl. especially aggressive and highly flammable ones. As a result of their low weight the pumps can be easily carried from container to container. The easy handling of motor and pump keeps changeover times short.

## F 430

With mechanical seal



### Advantages/characteristics:

- ▶ No carrying-over of the medium - one pump can be used for different media
- ▶ Easily dismantled for fast cleaning
- ▶ Immersion depth to 3 000 mm possible
- ▶ FOOD version available
- ▶ Stainless steel and Hastelloy C versions can be used in hazardous areas
- ▶ Available as version for dry running installation
- ▶ Steel core in the inner tube (PP and PVDF) provides greatest stability and prevents longitudinal changes at high and low temperatures

### Examples of media:

- ▶ Suitable for almost all low-viscosity fluids incl. FOOD media

Technical data	
Flow rate max.	240 l/min*
Head max.	30 mWs*
Viscosity max.	1 200 mPas*
Pump material Outer tube	Polypropylene, Polyvinylidene fluoride, Stainless steel, Alu- minium, Hastelloy C
Immersion length mm (standard)	700/1 000/1 200

## F 424

Sealless design



### Advantages/characteristics:

- ▶ Low-maintenance - due to sealless design
- ▶ Built to last
- ▶ Stainless steel version for use in hazardous areas
- ▶ Non-sensitive to dry running
- ▶ No contamination from lubricants or wear of seal materials possible

### Examples of media:

- ▶ Suitable for almost all low-viscosity media

Technical data	
Flow rate max.	240 l/min*
Head max.	30 mWs*
Viscosity max.	1 200 mPas*
Pump material Outer tube	Polypropylene, Poly- vinylidene fluoride, Stainless steel
Immersion length mm (standard)	700/1 000/1 200

\* dependent on pump model, medium and motor

### F 427

Can be taken apart completely



#### Advantages/characteristics:

- ▶ Easy and fast disassembly for cleaning or sterilisation
- ▶ Can be completely stripped down to individual parts without using tools
- ▶ Minimal dead spots
- ▶ Also available as FOOD and 3A certified version

#### Examples of media:

- ▶ Suitable for almost all applications; also for products in the pharmaceutical, FOOD and cosmetics industries

Technical data	
Flow rate max.	240 l/min*
Head max.	13 mWs*
Viscosity max.	1 000 mPas*
Pump material Outer tube	Stainless steel
Immersion length mm (standard)	700/1 000/1 200

### F 425

For 99.98 % drum emptying



#### Advantages/characteristics:

- ▶ Less than 0.05 l residual amount left in 200 l drum
- ▶ Flowback stop valve prevents back flow of the medium into the emptied drum
- ▶ With optimal use of the product reduced drum cleaning or waste disposal costs
- ▶ Stainless steel version can be used in hazardous areas
- ▶ Highest stability provided by steel core in inner tube; no longitudinal changes at high and low temperatures

#### Examples of media:

- ▶ Valuable, high-quality liquids e.g. cosmetics additives
- ▶ Toxic, dangerous and environmentally damaging substances

Technical data	
Flow rate max.	130 l/min*
Head max.	13 mWs*
Viscosity max.	1 200 mPas*
Pump material Outer tube	Polypropylene, Stainless steel
Immersion length mm (standard)	700/1 000/1 200

### F 426

For mixing and/or pumping



#### Advantages/characteristics:

- ▶ For pumping and/or mixing inhomogeneous media
- ▶ Switch lever for easy changing between mixing/pumping and pumping – during running operation, too
- ▶ Easily disassembled for fast cleaning
- ▶ Stainless steel version can be used in hazardous areas
- ▶ Steel core in the inner tube prevents longitudinal changes at high or low temperatures

#### Examples of media:

- ▶ Paints, lacquers, 2-phase mixtures, emulsions

Technical data	
Flow rate max.	240 l/min*
Head max.	13 mWs*
Viscosity max.	1 200 mPas*
Pump material Outer tube	Polypropylene, Stainless steel
Immersion length mm (standard)	1 000/1 200

\* dependent on pump model, medium and motor

# Eccentric worm-drive pumps

For pumping low to high-viscosity media



FLUX eccentric worm-drive pumps are suitable for pumping thin to high-viscosity fluids. The displacement pumps work with low turbulence at a constant pressure and provide for a gentle and pulsation-free operation. Whereas the series F 550 pumps are used in the industrial sector the series F 560 is especially configured for the pharmaceuticals, food and cosmetics industries. All pumps can be used mobile and stationary, are made of only a few components and easy to disassemble.

There is a choice of versions for immersing in the material and for installing outside the container; versions with explosion protection, 3A certification and FLUX FOOD pumps (Directive (EC) 1935/2004 and FDA CFR 21 compliant). For connection of the motor there is a choice between bearing flange (S) and gear (GS). For pumping especially high-viscosity media there are drum emptying systems with eccentric worm-drive pumps available (see page 25).

## Technical data



<b>Motor connection</b>	<b>gear (GS)</b>	<b>flange (S)</b>
<b>Container/application</b>	~ 200 litre drums, IBCs, tanks and as process pump	
<b>Flow rate max.</b>	50 l/min*	
<b>Head max.</b>	80 mWs*	
<b>Viscosity max.</b>	30 000 mPas* (GS6 80 000 mPas*)	80 000 mPas*
<b>Motor drive types</b>	Electric, pneumatic	

## Additional advantages/characteristics F 560

Hygienic pump for use in pharmaceuticals, food and cosmetics industries

- ▶ Minimal dead spots
- ▶ Pump/shaft/worm easy to disassemble
- ▶ Available with inliner suction protection – also suitable for containers with inliners
- ▶ FOOD version for contact with foodstuffs according to directives EC 1935/2004 and FDA CFR 21
- ▶ 3A certified versions available



F 550 TR in action in the industrial sector – pumping viscous softener.



F 560 GS in operation in the hygiene sector – pumping raw material for a cream into a mixing vat.

\* dependent on pump model, medium and motor

### GS/GS6

#### Eccentric worm-drive pumps F 550/ F 560 with gear



- ▶ Connection of motor to pump fast and simple with union nut
- ▶ For fluids of up to 30 000 mPas (80 000 mPas with GS6)
- ▶ Gear ratio 1:15.9 (GS) or 1:6.75 (GS6)
- ▶ For use with electrical commutator motors and compressed air motors (drum pump version)
- ▶ Light for mobile use
- ▶ Available with 3A certification
- ▶ Explosion-protection version available
- ▶ Available as FLUX FOOD pump



### S

#### Eccentric worm-drive pumps F 550/ F 560 with bearing flange



- ▶ Connection of motor via bearing flange
- ▶ For fluids up to 80 000 mPas
- ▶ For use with three-phase motors, gear motors and compressed air motors
- ▶ Exact metering via impulse generator possible
- ▶ For long running periods
- ▶ Extremely quiet
- ▶ Long service life
- ▶ For stationary use
- ▶ Available with 3A certification
- ▶ With explosion protection certification, where required
- ▶ Available as FLUX FOOD pump



### TR

#### Eccentric worm-drive pumps F 550/F 560 for dry installation



- ▶ For containers which are not accessible from above
- ▶ Liquid must be free flowing
- ▶ For increasing pressure in process lines
- ▶ Can be mounted on trolley or panel
- ▶ For mobile or stationary use
- ▶ Connection of motor via bearing flange
- ▶ Versions with anti-clockwise/clockwise running
- ▶ Pumps for use in hazardous areas available
- ▶ Also available as FOOD version



# Suitable motors

For the FLUX pumps of the series F 300, F 400 and F 500

For pump series	F 300			F 400 and F 500 GS		
Type	Battery (brushless)	Commutator				
Motor type	FBM-B 3100	FEM 3070	FEM 4070	F 457	F 458	F 460 Ex
Image						
Protection class	IP 44	IP 24	IP 24	IP 24	IP 55	IP 55
Ex-marking	-	-	-	-	-	II 2 G Ex d e IIC T6
Certificates						
Venting	External	Internal	Internal	Internal	External	External
Voltage (volts) Frequency	110 - 120/ 220 - 240 V 50 - 60 Hz	100/110/120/230/240 V 50 - 60 Hz		110/120/ 230/240 V 50 - 60 Hz	12/24/110/120/230/240 V 50 - 60 Hz	
Power (watts)	100	230	500	800	460/700	460/700
Speed setting	Variable	2 steps	Stepless	Optional	Optional	Optional
Weight (kg)	1.2	1.5	2.6	4	5.1/5.9	5.1/5.9
Low voltage protection	-	-	Optional	Optional	Optional	Optional
Advantages/ characteristics	<ul style="list-style-type: none"> <li>▶ Brushless battery motor</li> <li>▶ No mains connection required</li> <li>▶ Can be utilised immediately at will</li> <li>▶ Long battery runtime up to 120 min</li> <li>▶ Maintenance-free</li> <li>▶ Battery charged within 30 min</li> <li>▶ Li-Ion battery</li> <li>▶ Awarded with the iF Product Design and red dot awards</li> </ul>	<ul style="list-style-type: none"> <li>▶ Commutator motor</li> <li>▶ With mains connection</li> <li>▶ Also for filling small quantities</li> <li>▶ Low overall weight</li> <li>▶ Connection between motor and pump via quick-action coupling</li> </ul>	<ul style="list-style-type: none"> <li>▶ Commutator motor</li> <li>▶ Low noise level</li> <li>▶ With infinitely variable rpm adjustment</li> <li>▶ Compact construction</li> <li>▶ Low weight</li> <li>▶ Awarded with iF Product Design Award</li> </ul>	<ul style="list-style-type: none"> <li>▶ Commutator motor</li> <li>▶ Most powerful drum pump motor</li> <li>▶ Low noise level</li> <li>▶ F 457 EL: with infinitely variable rpm adjustment</li> </ul>	<ul style="list-style-type: none"> <li>▶ Commutator motor</li> <li>▶ Extremely tough housing in aluminium</li> <li>▶ With acid-proof finish</li> <li>▶ Extremely low noise</li> <li>▶ Motor is completely encapsulated</li> <li>▶ F 458: 460 watts</li> <li>▶ F 458-1: 700 watts</li> <li>▶ F 458 EL: with infinitely variable rpm adjustment</li> </ul>	<ul style="list-style-type: none"> <li>▶ Commutator motor</li> <li>▶ Extremely tough housing in aluminium</li> <li>▶ Motor is completely encapsulated</li> <li>▶ F 460 Ex: 460 watts</li> <li>▶ F 460-1 Ex: 700 watts</li> <li>▶ F 460 Ex EL: 460 watts with infinitely variable rpm adjustment</li> </ul>



constructed according to ATEX Directive 94/9/EC, Category 2

				F 500 S		F 550 GS6
Brushless	Three-phase	Compressed air		Three-phase		
FBM 4000 Ex	F 414	F 416 Ex	FPM	DSM	Spur gear	F 403
						
IP 55	IP 55		IP 55	IP 55	IP 54	IP 55
II 2 G Ex d e IIC T6	-	II G cp IIC T6	II 2 G c T5	II 2 G Ex e II T3/T4	-	II 2 G Ex e II T3/T4
						
External	External	Compressed air	Compressed air	External	External	External
230 V 50 - 60 Hz	230/400 V 50 Hz	6 bar air pressure		230/400 V 50 Hz	380 - 500 V 100 Hz	230/400 V 50 Hz
600	550/750/1 100	470	600 - 2 000	800 - 1 100	55 - 550	550
Stepless	-	Optional	Via air volume	-	Stepless	-
6.2	8.8 - 12.8	0.9 - 1.4	5 - 10	12.5 - 23	11.9	8
Yes	-	-	-	-	-	-
<ul style="list-style-type: none"> <li>▶ Brushless motor</li> <li>▶ Extremely low wearing</li> <li>▶ Maintenance-free</li> <li>▶ Low life-cycle costs</li> <li>▶ With infinitely variable rpm adjustment</li> <li>▶ Especially low noise</li> <li>▶ Extremely tough housing with double skin in aluminium</li> </ul>	<ul style="list-style-type: none"> <li>▶ Three-phase gear motor</li> <li>▶ Increased running period possible</li> <li>▶ Available with motor protection switch or terminal box</li> <li>▶ Constant rpm</li> </ul>	<ul style="list-style-type: none"> <li>▶ Compressed air motor</li> <li>▶ Extremely light and easy to handle</li> <li>▶ Extremely powerful</li> <li>▶ F 416: with adjustable tip valve</li> <li>▶ F 416-1: without valve</li> <li>▶ F 416-2: with ball valve</li> </ul>	<ul style="list-style-type: none"> <li>▶ Compressed air motor</li> <li>▶ Extremely powerful</li> <li>▶ Low-maintenance</li> <li>▶ Cool running</li> <li>▶ FPM 4: 0.6 kW at 6 bars for media up to 25 000 mPas</li> <li>▶ FPM 6: 1.2 kW at 6 bars for media up to 50 000 mPas</li> <li>▶ FPM 8: 2 kW at 6 bars also for paste-like media</li> </ul>	<ul style="list-style-type: none"> <li>▶ Three-phase motor</li> <li>▶ Constant rpm</li> <li>▶ Extremely low noise</li> <li>▶ Available with 700 rpm or 930 rpm</li> </ul>	<ul style="list-style-type: none"> <li>▶ Spur gear drive motor</li> <li>▶ With frequency control</li> <li>▶ Adjustable speed 47-472 rpm</li> </ul>	<ul style="list-style-type: none"> <li>▶ Three-phase motor</li> <li>▶ Low wearing</li> <li>▶ Constant rpm</li> <li>▶ Extremely low noise</li> <li>▶ With speed 2 850 rpm for media with viscosity of up to 30 000 mPas</li> <li>▶ With speed 1 450 rpm for media with viscosity of up to 80 000 mPas</li> </ul>

# Centrifugal immersion pumps

For pumping and circulating large volumes incl. aggressive and abrasive media



FLUX centrifugal immersion pumps are used when larger flow rates, continuous running or special immersion lengths are required. They are especially suitable for pumping and circulating aggressive and abrasive media from small containers up to 4.1 m high tanks. There is a choice of different materials available depending on the chemical and thermal requirements. In addition sealless and horizontal versions are available. FLUX centrifugal immersion pumps are individually configured and manufactured according to the technical requirements in each case.

## Technical data

<b>Container/ application</b>	IBCs, tanks as process pump
<b>Flow rate max.</b>	74 m <sup>3</sup> /h*
<b>Head max.</b>	35 mWs*
<b>Viscosity max.</b>	2 500 mPas*
<b>Motor drive</b>	Electric

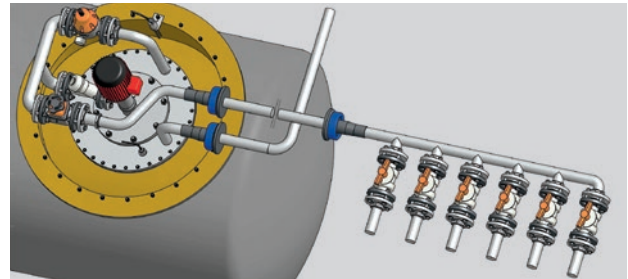

AdBlue® underground tank system - Supply of tap connection by FLUX centrifugal immersion pump F 640.



F 716 - Circulation of chemicals in an electroplating bath.



F 640 - Pumping of diluted sulphuric acid out of a pickling tank.

\* dependent on pump model, medium and motor



### Series F 600

Tank pump – for immersion lengths of up to 4 100 mm

#### Advantages/characteristics:

- ▶ Centrifugal pump
- ▶ Tank pump
- ▶ Suitable for tank heights up to 4.1 m without bottom opening
- ▶ Also pumps solids-laden fluids
- ▶ For mobile or stationary use
- ▶ Pump is hermetically tight
- ▶ Installation in pressurised tank or gas scrubber possible
- ▶ Motor replaceable
- ▶ Available as horizontal version for dry installation

#### Examples of media:

- ▶ Anodising solution
- ▶ Vegetable fibre suspension
- ▶ Water-based lacquers
- ▶ Alkaline pickling vats
- ▶ Industrial effluent
- ▶ AdBlue®

Technical data	
Flow rate max.	42 m <sup>3</sup> /h*
Head max.	32 mWs*
Viscosity max.	2 500 mPas*
Pump material Outer tube	Polypropylene, Polyvinylidene fluoride, Stainless steel
Immersion length mm (standard)	700/1 000/ 1 500/ 2 000 (up to 4 100 mm on request)

### Series F 700

Stationary circulating and filter pump – can also be used for continuous running

#### Advantages/characteristics:

- ▶ Vertical centrifugal pump
- ▶ Suitable for continuous operation
- ▶ Maintenance-free
- ▶ Sealless in liquid zone
- ▶ Extremely long lifetime
- ▶ Highest stability from steel core in the inner tube; no longitudinal change at high or low temperatures

#### Examples of media:

- ▶ Electroplating baths with e.g. copper sulphate, chromium and zinc electrolytes
- ▶ Chemically aggressive liquids such as anorganic and organic acids, lyes and salts

Technical data	
Flow rate max.	74 m <sup>3</sup> /h*
Head max.	35 mWs*
Viscosity max.	150 mPas*
Pump material Outer tube	Polypropylene, Polyvinylidene fluoride
Immersion length mm (standard)	300/500/700/ 1 000

\* dependent on pump model, medium and motor

# Air-operated diaphragm pumps

Self-priming pumps also for pumping abrasive media



FLUX compressed air-operated diaphragm pumps are self-priming and protected against dry running. The pumps are distinguished for their versatility and can be used for virtually all types of media. Available in heavy duty (RFM) or injection-moulded/cast (FDM) version for a huge diversity of applications they are designed for high pressures of up to 8 bars and in addition to other properties they are outstanding for their ease of handling. The 100 % start-up guarantee in every shut-down position guarantees reliability and safe operation. The flow is infinitely variable via the air pressure. In addition the flow rate is easy to calculate. As a result of the integrated silencer the compressed air-operated diaphragm pumps are low noise. In addition the pumps are low-maintenance, in particular if used for pure media.

## Technical data



<b>Application</b>	for IBCs, tanks and as process pump
<b>Flow rate max.</b>	1 040 l/min*
<b>Head max.</b>	200 mWs*
<b>Viscosity max.</b>	Just capable of flowing*
<b>Operating pressure max.</b>	8.6 bars*
<b>Suction head dry max.</b>	4.5m*
<b>Suction head product filled</b>	9.5m*

## Metering/control

- ▶ Versions with cycle control via solenoid valve available
- ▶ Version with fitted stroke counter available – combined with the evaluation unit FLUXTRONIC® it makes perfect metering possible (e.g. for colour mixing machines; for filling paint robots)



FDM: Pumping of chemical nickel for electroplating bath.



RFM: Pumping of concrete additives from IBCs into mixing tower.

\* dependent on pump model, operating pressure and medium

## RFM

### Heavy duty construction



#### Advantages/characteristics:

- ▶ Almost completely diffusion resistant due to the thick-surface structure
- ▶ Virtually no passive corrosion
- ▶ Due to composite enduring membrane even at high pressures
- ▶ Versions available with flap valves
- ▶ Extremely long service life even with abrasive media (e.g. enamels, slurries or abrasive glass dust)
- ▶ Quiet/low noise
- ▶ Versions available for use in hazardous areas
- ▶ FDA-certified version available

#### Examples of media:

- ▶ Highly concentrated sodium hydrochlorite
- ▶ Media containing chlorine
- ▶ Effluent from industrial hardening machinery
- ▶ Solvent mixtures
- ▶ Pickling vats

#### Technical data

<b>Flow rate max.</b>	375 l/min*
<b>Head max.</b>	70 mWs*
<b>Operating pressure max.</b>	7 bars
<b>Suction head product filled to max.</b>	8 m*
<b>Suction head dry max.</b>	4.5 m*
<b>Viscosity max.</b>	Barely capable of flowing*
<b>Solid matter size max.</b>	50 mm*
<b>Housing material</b>	Polypropylene, Polypropylene conductive, Polytetrafluorethylene, Polytetrafluorethylene conductive

## FDM

### Injection-moulded/cast version



#### Advantages/characteristics:

- ▶ Available in plastic and as metal version
- ▶ Oil-free operation
- ▶ Regulating valve insensitive to foreign matter in the air
- ▶ Version for increased pressure (3:1)
- ▶ Versions available for use in hazardous areas

#### Examples of media:

- ▶ Alcohols in pharmaceutical sector
- ▶ Petrol
- ▶ Chlorine bleach
- ▶ Cleaning agents
- ▶ Pickling
- ▶ Effluent

#### Technical data

<b>Flow rate max.</b>	1 040 l/min*
<b>Head max.</b>	200 mWs*
<b>Operating pressure max.</b>	8.6 bars
<b>Suction head product filled to max.</b>	9.5 m*
<b>Suction head dry max.</b>	4.5 m*
<b>Viscosity max.</b>	Barely capable of flowing*
<b>Solid matter size max.</b>	50 mm*
<b>Housing material</b>	Polypropylene, Acetal conductive, Polyvinylidene fluoride, Aluminium, Stainless steel, Grey cast iron

\* dependent on pump model, operating pressure and medium

# Flow meters

For manual or semi-automatic filling of different fluids



FLUX flow meters constructed on the nutating disc principle (FMC), oval rotor (FMO) or the turbine principle (FMT), provide the right solution for every application. Depending on model and overall size they can be used on e.g. FLUX drum pumps or stationary e.g. in pipe lines. Using the digital display unit FLUXTRONIC® for FMC and FMO filling and metering processes can be carried out for virtually all liquids with maximum precision and the greatest possible safety. In automatic mode there is the possibility of transmitting signals for control purposes. In this way differing processes can be regulated.

## Technical data



	FMC/FMO/FMT
<b>Flow rate max.</b>	max. 380 l/min*
<b>Viscosity max.</b>	500 000 mPas*
<b>Operating pressure max.</b>	200 bars*
<b>Application</b>	Stationary or mobile with drum or eccentric worm-drive pumps



Semi-automatic can filling in explosion zone 1.

## FLUXTRONIC®

Due to the digital display unit FLUXTRONIC® fitted to flow meters FMC and FMO there are two operating modes available. Whereas in "normal mode" only the flow volume is displayed, in automatic mode it is possible to fill pre-programmed amounts of liquid semi-automatically – at the push of a button. As soon as the desired quantity has been filled two signals can be transmitted. In this way for example a valve or drive motor can be controlled or the signal transferred to a PLC.



Digital display unit FLUXTRONIC® can be fitted to flow meter or directly to the hand nozzle.

\* dependent on version, material, overall size and media

### Flow meter FMC

For low-viscosity fluids also slightly soiled



#### Advantages/characteristics:

- ▶ Constructed on the nutating disc principle
- ▶ Non sensitive to small particles
- ▶ Media temperatures up to 80 °C
- ▶ Easy handling
- ▶ High wear resistance – large choice of materials
- ▶ Non sensitive functional principle
- ▶ Low weight
- ▶ For low-viscosity media
- ▶ Operational in any installed position
- ▶ Can be calibrated

#### Examples of media:

Formic acid, arsenic acid, boric acid, brake fluid, calcium chloride, acetic acid, iron III chloride, glycol, sodium hydroxide, zinc chloride, citric acid, flammable media

Technical data	
Flow rate min.	10 l/min*
Flow rate max.	250 l/min*
Viscosity max.	2 500 mPas*
Operating pressure max.	6 bars*
Housing material	Polypropylene, Ethylene tetrafluorethylene, Stainless steel, Polyvinylidene fluoride
Application	Stationary or mobile with drum pump*

### Flow meter FMO

For pure fluids incl. high-viscosity liquids



#### Advantages/characteristics:

- ▶ Constructed on the oval rotor principle
- ▶ Very precise metering possible
- ▶ Media temperatures up to max. 120 °C
- ▶ High wear resistance
- ▶ Also for high pressures
- ▶ Extensive flow volume range
- ▶ Extensive viscosity range
- ▶ Can also be used with pulsating flows – e.g. in combination with compressed air-operated diaphragm pumps
- ▶ Low pressure loss
- ▶ Can be calibrated

#### Examples of media:

Oils, petrol, solvents incl. media which are not self-lubricating

Technical data	
Flow rate min.	0.09 l/min*
Flow rate max.	380 l/min*
Viscosity max.	500 000 mPas*
Operating pressure max.	200 bars*
Housing material	Polyvinylidene-fluoride, Stainless steel, Aluminium
Application	Stationary or mobile with drum or eccentric worm-drive pumps*

### Flow meter FMT

For pure low-viscosity fluids

#### Advantages/characteristics:

- ▶ Constructed on the turbine principle
- ▶ For JUNIORFLUX/COMBIFLUX pumps
- ▶ Easy to handle
- ▶ For small quantities
- ▶ Simple counting unit – no evaluation possible

#### Examples of media:

Neutral, aggressive, low-viscosity, non-flammable liquids

Technical data	
Flow rate min.	5 l/min*
Flow rate max.	50 l/min*
Viscosity max.	40 mPas*
Operating pressure max.	4 bars*
Housing material	Polypropylene
Application	Mobile with JUNIORFLUX/COMBIFLUX pumps

\* dependent on version, material, overall size and media

# Mixers

Can be custom configured for any mixing operation



Anyone who wants to disperse, emulsify, homogenise, chill, dissolve, mix, neutralise, stir, circulate or exchange heat efficiently is faced with a demanding task – from a technical and physical point of view. The mixing effect that flows develop depends on the shape of the container, the material and of course the type of mixer. Due to the flexible modular system FLUX is able to offer a wide range of options. This makes it possible to configure the mixer components of motor, shaft and mixing blade optimally for the application's requirements.

## Fast runners

For low to medium viscosity media and small containers

### Advantages/characteristics:

- ▶ Circulating performance up to 650 m<sup>3</sup>/h
- ▶ Speeds 750 – 1 500 rpm
- ▶ Several mixing blades can also be mounted on top of each other
- ▶ Ideal for liquids of up to 2 500 mPas
- ▶ Configured for fluids with max. 5 % solid content
- ▶ Suitable for IBCs and tanks of up to approx. 4 000 l
- ▶ For continuous flow systems with 5-20 fold flow per hour

### Examples of media:

- ▶ Milk of lime with solution of up to 5 %
- ▶ For chemicals use e.g. aluminium sulphate, ferric chloride



## Slow runners

For high circulation performance

### Advantages/characteristics:

- ▶ Circulating performance up to 3 600 m<sup>3</sup>/h
- ▶ Low speed of approx. 70 rpm
- ▶ For fluids of up to a viscosity of 10 000 mPas
- ▶ With gear
- ▶ Versions available with sliding or folding agitators
- ▶ Can be used in tanks
- ▶ For liquids with max. 10 % solids
- ▶ For run-through systems with 10 – 40 fold flow per hour

### Examples of media:

- ▶ Milk of lime with solution of up to 30 %
- ▶ Flocculant additive with a viscosity of 300 mPas



# Additional products and accessories

Comprehensive range of accessories for all FLUX pump models



To supplement the diverse range of pumps FLUX has a wide range of accessories on offer. Whether for mobile or static deployment - with the FLUX range of accessories a FLUX pump can be turned into a custom-made pumping system for any area of application or purpose. It provides smooth and safe running and at the same time makes work easier. For example it is possible to lift a FLUX pump out of the drum without any exertion thanks to the stirrup handle and spring balance. Space saving storage equipment allows pumps to be economically stored. Furthermore for every application there is e.g. the right hose - pre-configured and integrated in the required length. For typical drum pump applications there are pre-configured pump sets available.

## Fume gland

For aggressive and corrosive media

### Advantages/characteristics:

- ▶ Hermetically seals container
- ▶ The venting valve ensures that the pressure of the tank being emptied is compensated.
- ▶ Optimum protection for operator and environment
- ▶ Where necessary the motor is protected from corrosive vapours
- ▶ Designed for FLUX drum pumps series F 300, F 400 and F 500

### Examples of media:

Acids, lyes and media with aggressive and hazardous vapours

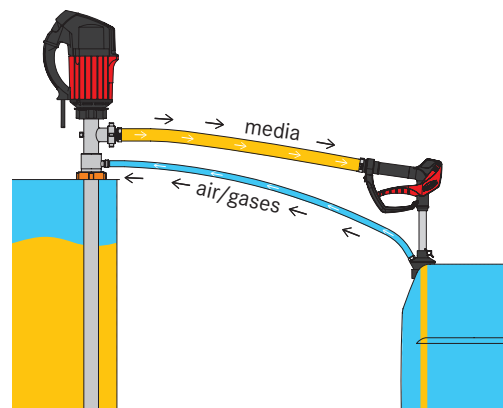

## Hand nozzles

For simple filling

### Advantages/characteristics:

- ▶ Ergonomically shaped hand lever
- ▶ Easy to operate
- ▶ Fine metering
- ▶ Ball-bearing mounted swivel joint
- ▶ Low pressure loss
- ▶ High flow rate
- ▶ Can be combined with stop valve, emission-protection cone and various outlet nozzles

### Examples of media:

Boric acid, phosphorous, hydrochloric acid and sulphuric acid, potassium and sodium hydroxides, ammonium water and hydrobromic acid



# Filling units

Manual and semi-automatic metering systems for use with drum pumps



FLUX filling systems provide everything required for the fast and safe emptying of containers. They provide an economical alternative to conventional automatic filling machinery and stations. A FLUX filling system is comprised of a combination of suitable drum pump and drive motor specially configured for the application, hose line and discharge fitting. Metering via the discharge fitting can be made either manually by using a hand nozzle or semi-automatically in combination with a flow meter via the FLUX filling unit (FAE).

## Manual filling systems

For fast and safe filling of various media from drums and IBCs

There is a choice of pre-configured pump sets consisting of the components drum pump, drive motor, hose line and hand nozzle. These are available for:

Acids and lyes, concentrated acids and AdBlue®, mineral oil products, highly flammable liquids, universal applications; 99.98 % drum emptying

Furthermore all pumps can be combined with individually selectable accessories to form a customized set for the particular application. For example together with a flow meter for improved metering.



## Semi-automatic filling units

Fast and safe metering of preset quantity

### Advantages/characteristics:

- ▶ Fill quantity setting via FLUXTRONIC®
- ▶ Economic alternative to conventional automatic filling machines and stations
- ▶ Two versions:
  - radio controlled (Directive 1999/5/EC compliant) or wired in (e.g. can also be used in hazardous areas)
- ▶ Comprising drum pump, drive motor, hose line, flow meter, circuit amplifier and FLUX filling unit
- ▶ Discharge fitting – semi-automatic; filling operation is controlled via start/stop button





# Drum emptying systems VISCOFLUX

For pumping high-viscosity media out of lidded drums

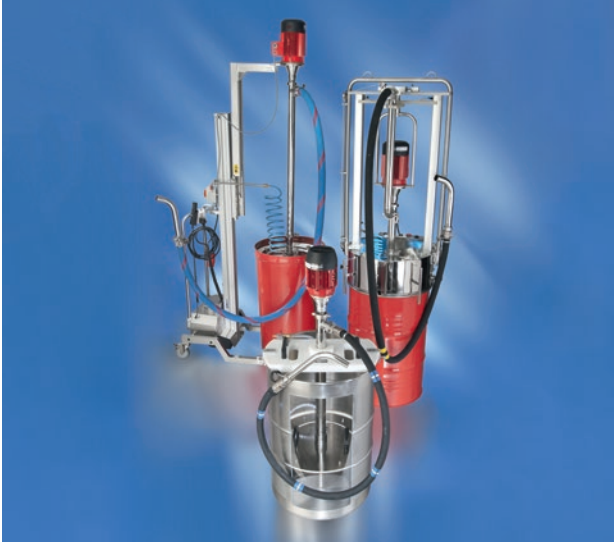

VISCOFLUX drum emptying systems were specially developed for emptying lidded drums with high-viscosity contents. The medium is continuously and particularly carefully extracted with FLUX eccentric worm-drive pumps. All systems achieve an almost complete emptying of the drum with < 1 % residual amount (under 2 % for drums with liners).

Whereas the VISCOFLUX lite is ideal for pumping high-viscosity media barely capable of flowing the VISCOFLUX and VISCOFLUX mobile are capable of pumping high-viscosity media not even capable of flowing by themselves.

## VISCOFLUX lite

The FLUX specialist for pumping high-viscosity media just capable of flowing.



### Advantages/characteristics:

- ▶ Only a few components means fast fitting
- ▶ For ISO lidded drums with outside Ø 571.5 mm
- ▶ Non-explosion protected version designed for pump with Ø 54 mm, Ex-protected version for pump with Ø 50 mm

### Examples of media:

- ▶ From media barely capable of flowing to grease classification 2
- ▶ Soft lubricating grease (NLGI classification 0-2)
- ▶ Base material for lacquers, adhesives, construction bonds and fixing compounds

## VISCOFLUX

The FLUX specialist for high-viscosity media



### Advantages/characteristics:

- ▶ High flexibility provided by mobility of system
- ▶ User-friendly handling
- ▶ Pumps media not capable of flowing on their own
- ▶ Remaining residue in drum < 1 %
- ▶ FDA CFR 21 compliant available

### Examples of media:

- ▶ Vaseline
- ▶ Lanolin
- ▶ Semi-solid lubricants (NLGI classification 3)
- ▶ Lacquers and silicones
- ▶ Fibre-reinforced composites

## VISCOFLUX mobile

The stand-alone solution for pumping high-viscosity media



### Advantages/characteristics:

- ▶ Stand-alone system uses mobile process equipment
- ▶ Easy to clean
- ▶ Also for conical, board and seaworthy container drums
- ▶ Various control possibilities optional
- ▶ FLUX FOOD version available, suitable for foodstuffs according to EC 1935/2004 and FDA CFR 21

### Examples of media:

Industrial version:

- ▶ Coating and casting compounds
- ▶ Lacquers

Pharmaceuticals, foodstuffs and cosmetic sector version:

- ▶ Tomato purée (also from drums with liners)
- ▶ Creams and ointments e.g. zinc oxide ointments
- ▶ Vaseline

# Customized all-in solutions

From pump kits to comprehensive systems

FLUX offers a lot more than just pumps. As well as a great diversity of pumps and suitable motors FLUX has an extensive range of ancillary products and accessories. After the analysis of the problem by the FLUX consultant complete customized solutions are developed. These can extend from small-scale product configurations through to complex systems.

**Practical examples of customized all-in solutions by FLUX:**

## Task:

Filling of 10, 20 and 60 litre cans and 200 l drums from IBC stacked or on racking.

### Components used:

- ▶ FLUX drum pump F 430 S TR
- ▶ FLUX commutator motor F 457
- ▶ PVC hose
- ▶ FLUX flow meter FMC 100 in stainless steel with digital display unit FLUXTRONIC®
- ▶ 2-way valve
- ▶ Circuit amplifier FSV 100 for controlling the motor and 2-way valve
- ▶ Mineral oil hose integrated
- ▶ Wired in filling unit
- ▶ Stainless steel panel (mounted to the struts of the IBC)

### Advantages/characteristics:

- ▶ Quantity to be filled is preset via the FLUXTRONIC® and filling is started by pressing a button on the filling unit



Material: Mineral oils and machining oils

## Task:

Filling of highly toxic media

### Components used:

- ▶ FLUX drum pump F 425 in stainless steel for 99.98 % drum emptying
- ▶ FLUX commutator motor F 457 EL
- ▶ FLUX flow meter FMC 100 in stainless steel
- ▶ 2-way valve
- ▶ Circuit amplifier FSV 100 to control the motor and 2-way coaxial valve
- ▶ Emission protection valve for drum pump
- ▶ Emission protection cone for drum being filled

### Advantages/characteristics:

- ▶ Personnel and environment are protected from the toxic vapours
- ▶ Almost no medium whatsoever is left in the drum



# Custom made design

Special custom solutions from the house of FLUX



The solutions to some tasks make additional designing necessary. This too is carried out by FLUX in-house. Depending on the task involved the appropriate specialist is drawn from a team of multiple experts. Irrespective of whether a minor or major design assignment is concerned – FLUX maps out the complete process from the idea to the finished custom solution including documentation compliant with Machine Directive 2006/42/EC.

## FLUX practical examples of custom made design:

### Task:

Pump chemicals in closed mobile system into mixing containers.

#### Media:

- ▶ Nitric acid, Tetraethylammoniumhydroxide

#### Technical data

- ▶ Flow rate: 2-4 l/min

#### Components used:

- ▶ FLUX drum pump F 424 in stainless steel
- ▶ FLUX commutator motor FEM 4070
- ▶ FLUX Flow meter FMO 2
- ▶ Circuit amplifier to control the motor and warning lamp
- ▶ Emergency switch
- ▶ Stainless steel hose with quick coupling for mixing container
- ▶ Transport wagon with catch basin

#### Special feature:

- ▶ One-off custom production which was designed, manufactured and certified at FLUX



### Task:

Emptying and filling of silo trucks

#### Media:

- ▶ Solvents, acids, lyes, non-chlorinated

#### Technical data

- ▶ Temperature of medium: 60 °C
- ▶ Flow volume: 300 l/min

#### Components used:

- ▶ FLUX air-operated diaphragm pump FDM 40
- ▶ Pulsation damper

#### Special feature:

- ▶ Components were installed on a wagon especially designed for silo trucks. This can simply be attached and carried along.





More than just pumps

Today the FLUX name is recognised around the globe as the trademark for top standards in pump technology. Everything started with the invention of the electric drum pump in 1950. Nowadays FLUX has an extensive range of products each of which can be customized. FLUX pumps are used for example in the chemical and pharmaceutical industries; in machinery and plant engineering as well as companies in electroplating, effluent treatment and the foodstuffs sector.

Whether single-product or system solution – FLUX quality is synonymous with a long service life, excellent economy and maximum safety.

In addition to the excellent product quality FLUX customers appreciate the superb level of expertise our staff has to offer as well as their genuine customer focus.

These days FLUX-GERÄTE GMBH supplies pumps to almost 100 countries around the globe.

FLUX PUMPS CORPORATION  
BARREL & CONTAINER PUMPS  
300 Townpark Drive  
Suite 110  
Kennesaw, GA 30144  
800 367 3589  
[www.fluxpumpsusa.com](http://www.fluxpumpsusa.com)  
[info@fluxpumpsusa.com](mailto:info@fluxpumpsusa.com)