

## EVMSU Series - Vertical Multistage Pumps

Product Brochure



# Built like a Katana

A Katana is a traditional Japanese sword made with distinctive, longstanding expertise started in 300 A.D. Katana are manufactured with care and precise attention to detail. Only years of experience can provide the ability necessary to build a masterpiece.

This is what we do with our pumps. Our 110 years of Japanese expertise in our pump design and manufacturing is the basis for developing pumps with high quality and reliability as well as cutting edge components and performance.

We look forward, not forgetting the past.

EBARA new vertical multistage pumps – model EVMSU – are manufactured with the highest standards of quality to achieve reliable operating performance through strict technical evaluation criteria and control programs that involve the whole manufacturing process.

We listened to the market. Our design is unique. The EVMSU offers exceptional value through cutting-edge solutions to suit your application needs.

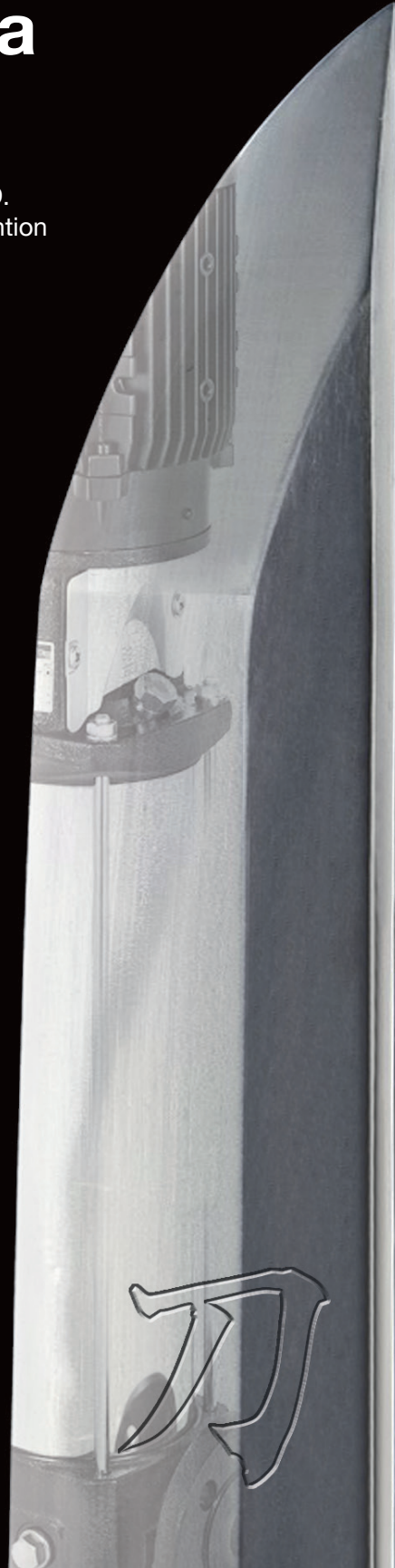

# Precision, Quality, Cutting-Edge



## FEATURES

- Standard NEMA motor sizes
- Optionally available Low NPSH 1st stage impeller significantly reduces NPSH requirements.
- Low axial thrust impeller enables long motor bearing life
- Air vent in casing cover allows proper venting preventing air entrapment and dry run
- Fill port in casing cover allows for water fill, as well as installation of sensors, gauges, and other measuring devices
- Liner ring is a self-aligning, floating design constructed to prevent swelling at high temperatures
- Tungsten carbide lower pump bearings and sleeves are standard construction for all services, providing maximum operating life
- Direct drive pump and motor shafts are keyed for positive, reliable power transmission with no adjustments necessary
- “Flexible” floating outer casing allows for thermal expansion in hot water applications, preventing deformation due to pressure fluctuations
- Square-edge four spline shaft provides positive location and drive of impellers, eliminating wear
- Dimensions & flanges – installation is to market accepted dimensions for easy upgrade of existing installations
- Piping connection options include Fixed ANSI compatible flange, Oval flange, Loose ANSI compatible flange, victaulic, and clamp connections
- Mechanical seal – Silicon Carbide/Carbon/Viton mechanical shaft seal. Cartridge mechanical seal design enables plug in replacement without disassembling the motor bracket



Certified to  
NSF/ANSI/CAN 61  
& 372

**\*Note:** Model EVMSU with seal code “S” is Certified  
Low NPSH models and models with optional seal types are not certified.

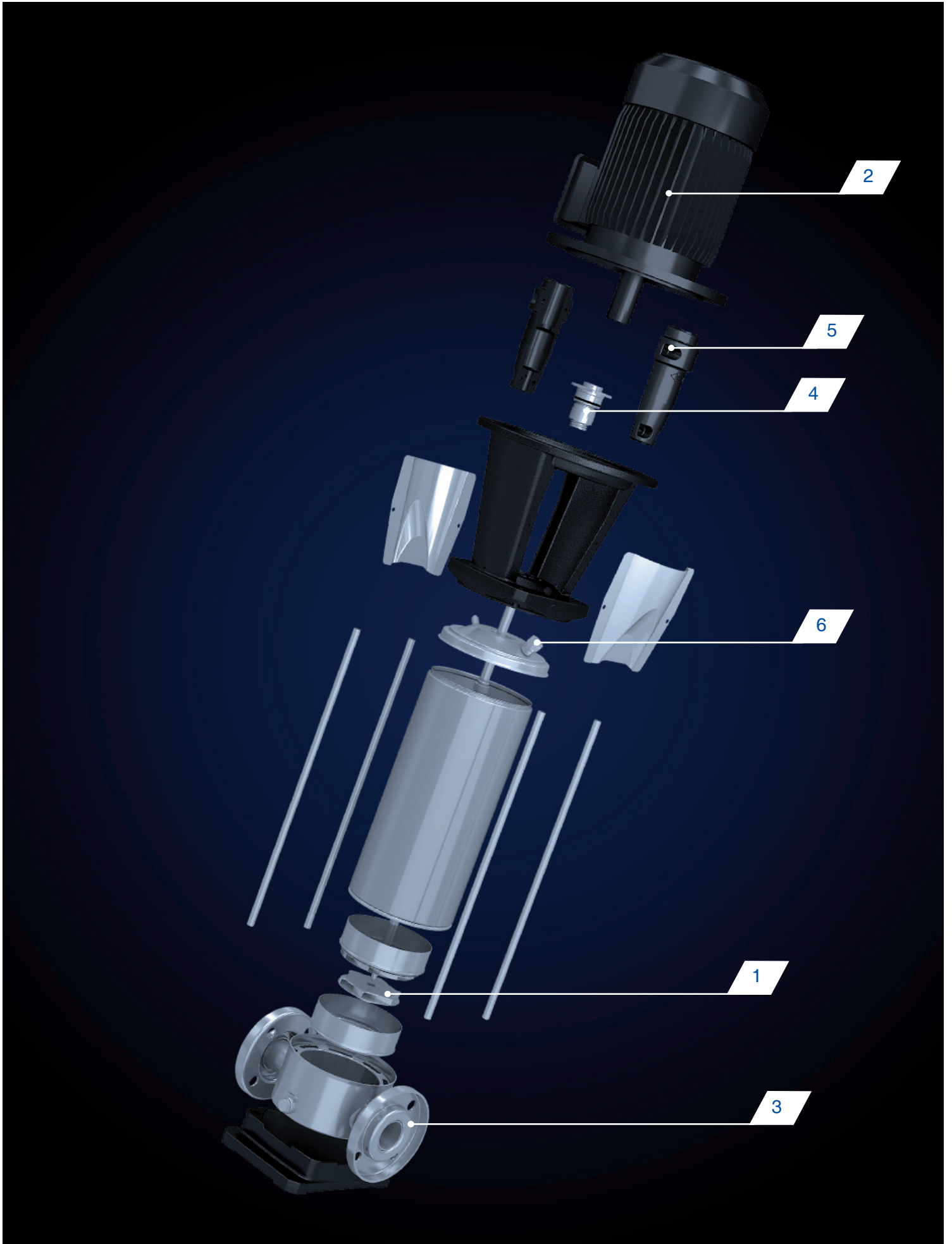

# Main product features



## Innovative hydraulic solutions

Any motor, anywhere.

- The Shurrricane impeller reduces axial thrust load
- Long life of standard motor bearing

Patent application pending

## 2



## Motor flexibility

- Standard NEMA motor sizes can be fitted with no modifications thanks to low axial thrust load.
- Allows a wider range of motors to be used.

## 3

## Piping connection options

- Optional pipe connections are available depending on the application requirements
- Dimensions & flanges - installation is to market accepted dimensions for easy upgrade in existing installations

Material

Round flange  
ANSI Compatible

Loose Flange  
ANSI Compatible

Oval Flange

Plug-In connection  
(victaulic)

AISI304/  
AISI316



\*EVMSUN Low NPSH only available with Round Flange as standard

## 4



## Shaft seal solutions

- **Shaft seal material:**  
B: Resin impregnated carbon graphite  
Q: Sintered silicon carbide  
Qg: Silicon carbide with carbon graphite

Carbon or graphite inclusions with silicon carbide can be used as **reduce friction**.

- Conforms to EN12756 (ex DIN 24960)

## 5

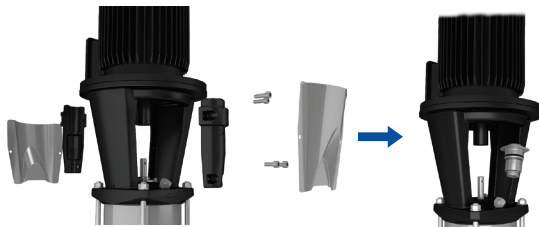

## Easy maintenance

- The **spacer coupling** allows easy maintenance without having to remove heavy motors over 5 HP.
- The **cartridge shaft seal** enables **replacement** of the shaft seal without disassembling the motor bracket

## 6

## Smart plug solutions



Air ventilation plug



Water filling  
& sensor plug

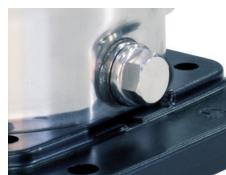

Drain plug



# Reliability is made by numbers

**1**  
Million

Cycles of the endurance test\*

**2**  
Times

Higher test criteria than nominal operating conditions\*

**3**  
Times

Lower thrust load than common pumps

\* for main components

## Solve axial thrust load



Axial thrust load in a pump is caused by unequal distribution of pressure between the front and back shrouds of an impeller. Axial thrust loading often leads to reduced life of the the motor bearings.

General methods to absorb the axial thrust load include:

- Increasing the motor bearing size or using enhanced motor bearings.
- Mounting additional ball bearings on the pump bracket.



**EBARA's newly designed "Shurricane" impeller reduces the axial thrust load with higher pump efficiency created by the innovative hydraulic design of the impeller shrouds.**

**The EVMSU can accept commercial motors without any modifications and improve the maintenance cycles of motor bearings.**

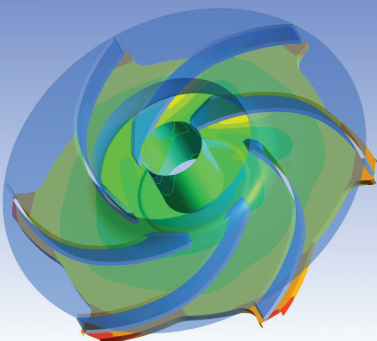
**Any motor, anywhere.**



# Typical Application

INDUSTRY	BUILDING SERVICE	WATER SUPPLY
		
<ul style="list-style-type: none"> <li>• <b>Water treatment</b> reverse osmosis ultra-filtration water purification micro-filtration softening, ionizing and demineralising systems swimming pools separators</li> <li>• <b>Boiler feed</b> steam systems condensate systems</li> <li>• <b>Wash and clean</b> vehicle washing systems industrial part washing laundry systems supply of liquids with acids and bases supply of chemical liquids</li> <li>• <b>Chilling</b> handling of refrigerants for cooling thermal control systems industrial cooling laser cooling</li> <li>• <b>Machine tool</b> cooling lubricant supply for machine tools</li> <li>• <b>Pressure boosting</b> pressure boosting for industrial use</li> <li>• <b>Food &amp; beverage</b> food washing systems bottle wash systems</li> <li>• <b>Pharmaceutical industries</b></li> <li>• <b>Marine applications</b> freshwater, deckwash, high fog and fire fighting on ships</li> </ul>	<ul style="list-style-type: none"> <li>• <b>Pressure boosting</b> pressure boosting for buildings pressure boosting for high rise buildings/hotels</li> <li>• <b>Sprinkler systems</b></li> <li>• <b>Fire fighting systems</b> jockey pump</li> <li>• <b>District heating</b></li> <li>• <b>Heat exchangers / fan heaters</b></li> <li>• <b>Air conditioning systems</b></li> <li>• <b>Heating systems</b></li> </ul>	<ul style="list-style-type: none"> <li>• <b>Water treatment</b> water treatment plants filtration water treatment plants transfer</li> <li>• <b>Pressure boosting</b> transfer from water treatment plants (mains)</li> <li>• <b>Irrigation</b> golf course / sport fields irrigation</li> <li>• <b>Agriculture</b> sprinkler irrigation drip irrigation</li> </ul>



# Performance Range

60Hz

## EVMSU(G)(L) 1-90

EVMSU(.) 1-90

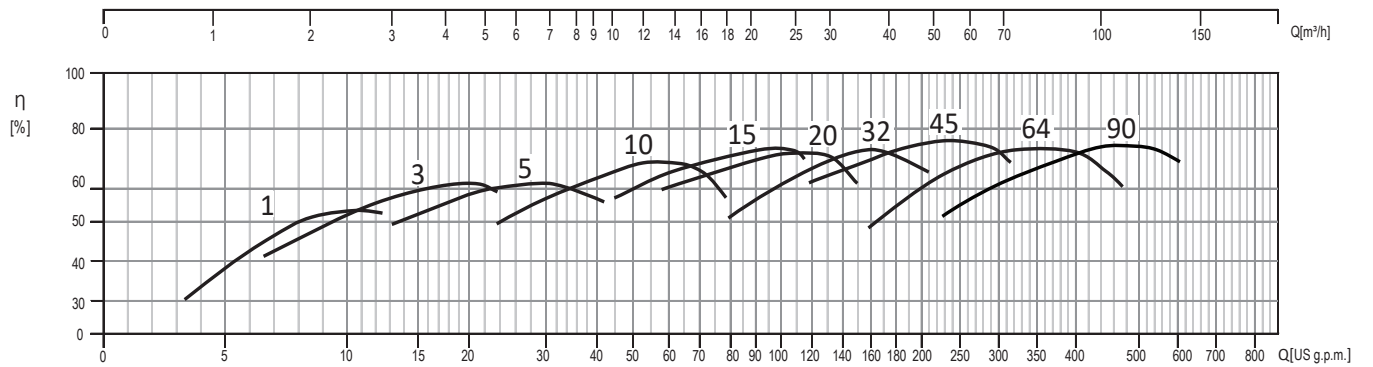
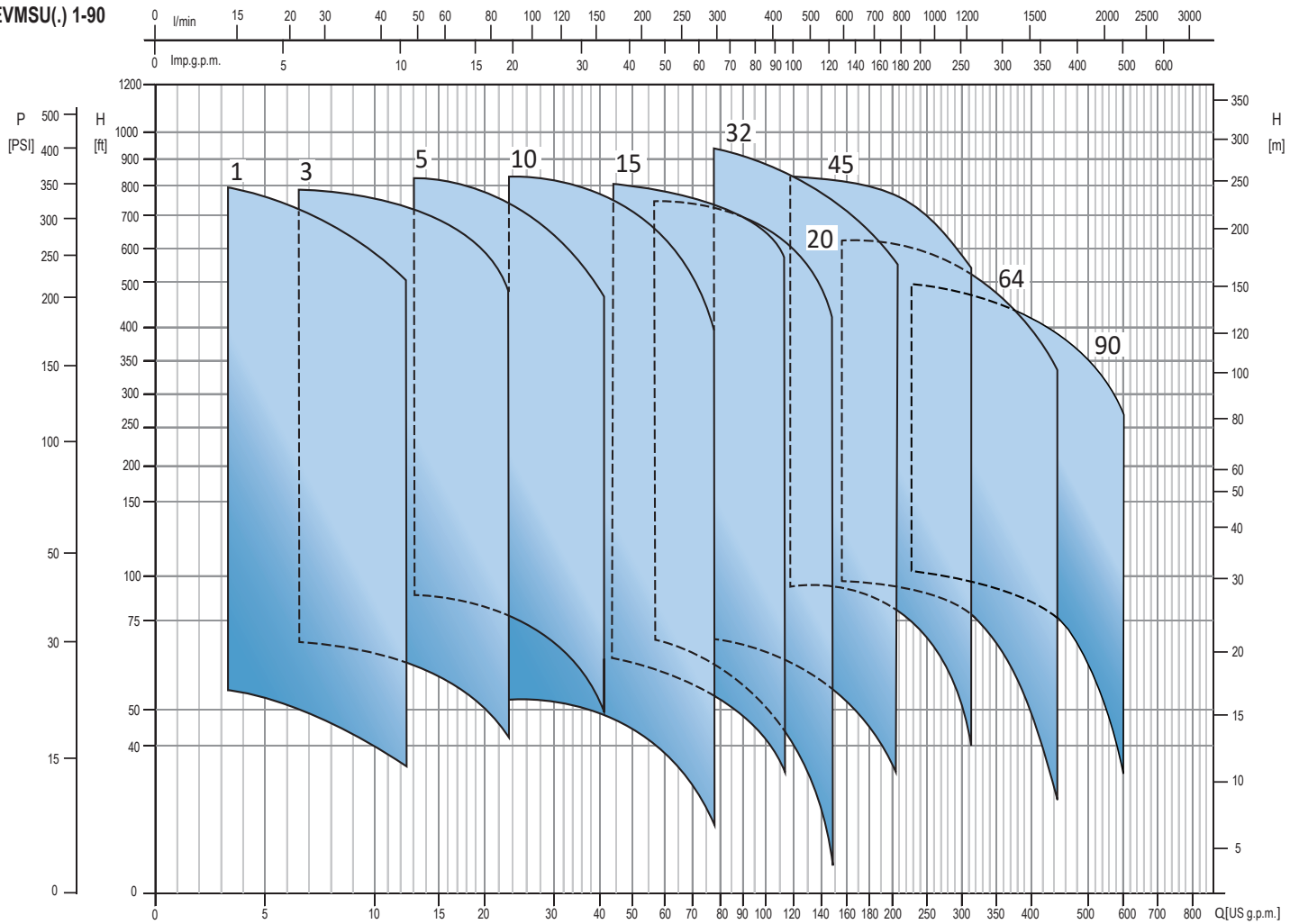

Model EVMSU5	PE <sub>CL</sub> 0.89	Imp. Dia. 3.58 (in.)
Model EVMSU10	PE <sub>CL</sub> 0.92	Imp. Dia. 3.78 (in.)
Model EVMSU15	PE <sub>CL</sub> 0.97	Imp. Dia. 4.21 (in.)
Model EVMSU20	PE <sub>CL</sub> 0.99	Imp. Dia. 4.45 (in.)
Model EVMSU32	PE <sub>CL</sub> 0.96	Imp. Dia. 4.56 (in.)
Model EVMSU45	PE <sub>CL</sub> 0.93	Imp. Dia. 5.52 (in.)
Model EVMSU64	PE <sub>CL</sub> 1.00	Imp. Dia. 5.61 (in.)
Model EVMSU90	PE <sub>CL</sub> 1.00	Imp. Dia. 5.76 (in.)

# Performance Range

60Hz

EVMSU(L)N 3-5-10

Low NPSH

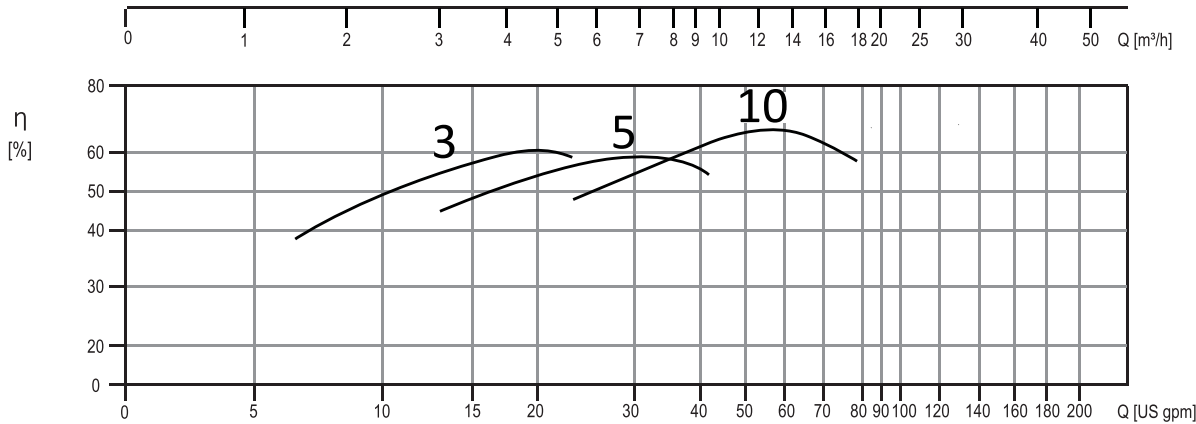
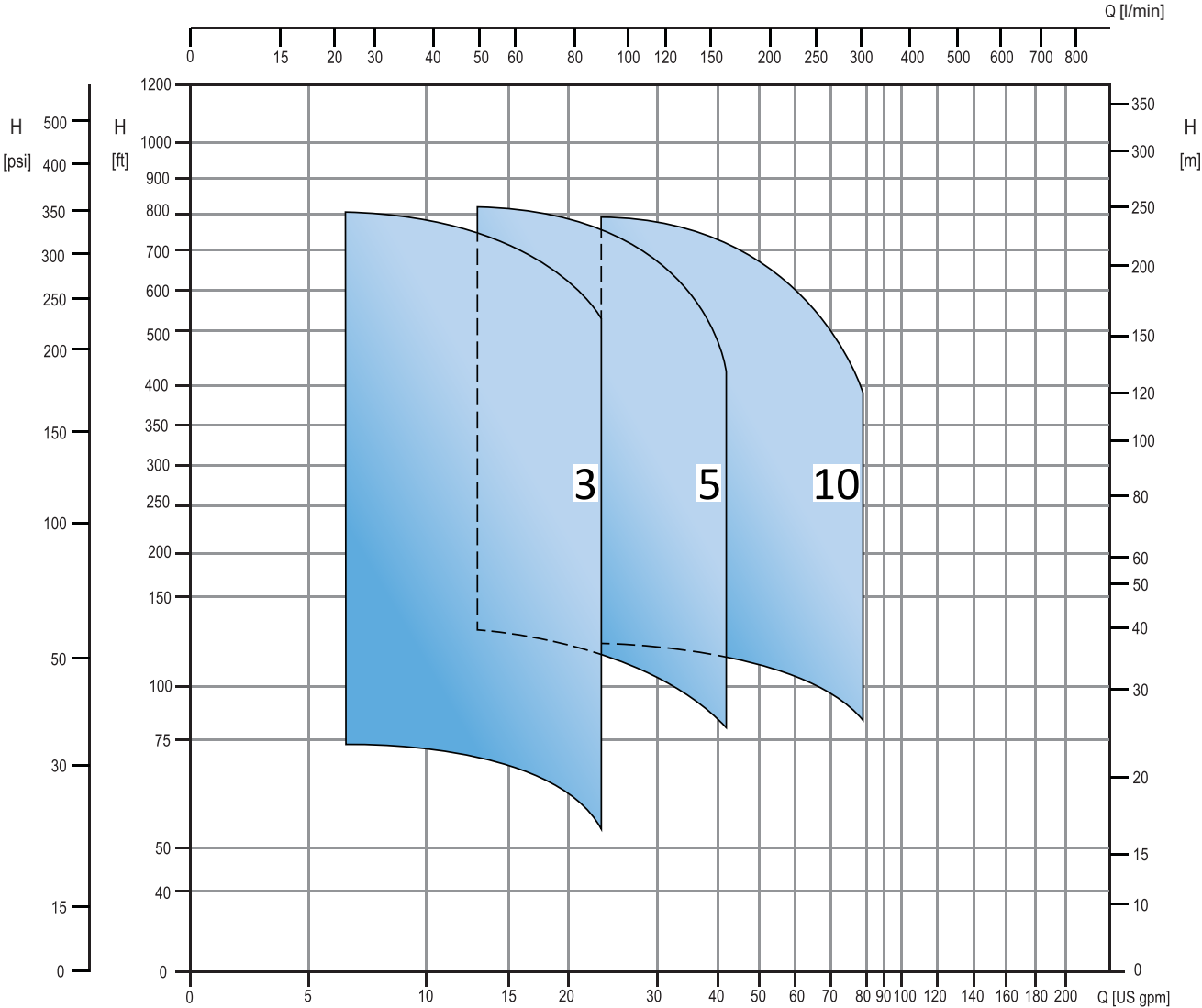

Model EVMSUN5 PEI<sub>CL</sub> 0.97 Imp. Dia. 3.58 (in.)  
 Model EVMSUN10 PEI<sub>CL</sub> 0.98 Imp. Dia. 3.78 (in.)

# Sectional Drawing

EVMSU(L) 1-3-5-10-15-20  
EVMSUN 3-5-10  
Low NPSH

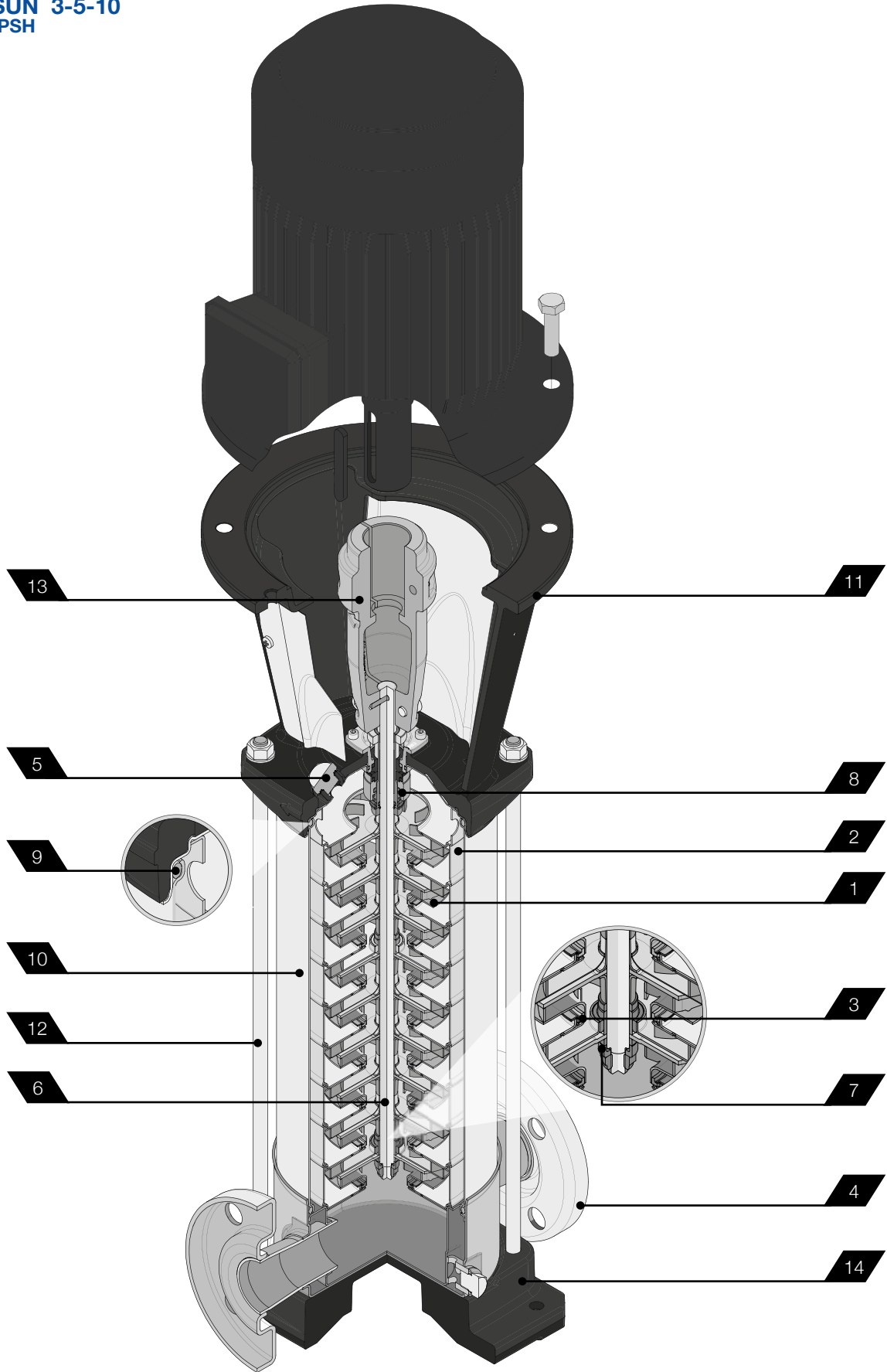

# Product Specifications

EVMSU(L) 1-3-5-10-15-20

PUMP														
Version		EVMSU					EVMSUL							
Performance range	Nominal size	1	3	5	10	15	20	1	3	5	10	15	20	
	Motor Power	1/2 to 25 HP												
	Capacity	2.9 to 132.1 gpm												
	Total Head	24.3 to 860 ft												
Liquid Handling	Type of liquid	Clean water (for other clean liquids, consult factory)												
	Maximum working pressure	230 / 375 PSI (depending on model)												
	Liquid temperature range	-22°F to 248°F (-30°C to 120°C)												
Size	Suction	1 1/4"		2"			1 1/4"		2"					
	Discharge	1 1/4"		2"			1 1/4"		2"					
Key Component Materials	Impeller	AISI 304 (EN 1.4301)					AISI 316 (EN 1.4401)							
	Intermediate casing	AISI 304 (EN 1.4301)					AISI 316 (EN 1.4401)							
	Liner ring	AISI 304 (EN 1.4301) + PPS					AISI 316 (EN 1.4401) + PPS							
	Bottom casing	AISI 304 (EN 1.4301)					AISI 316 (EN 1.4401)							
	Casing cover	AISI 304 (EN 1.4301)					AISI 316 (EN 1.4401)							
	Shaft	AISI 304 (EN 1.4301)	EVMSU 1-3-5, EVMSU 10-15-20 (depending on model)											
		AISI 316L (EN 1.4404)	EVMSUL 1-3-5, EVMSUL 10-15-20 (depending on model)											
		AISI 329A (EN 1.4462)	EVMSU / EVMSUL 5-15-20 (depending on model)											
	Shaft sleeve bearing	Tungsten carbide												
	Shaft Seal	SiC/Carbon/FPM	●	●	●	●	●	●	●	●	●	●	●	●
		SiC+Graphite/SiC/FPM	○	○	○	○	○	○	○	○	○	○	○	○
		SiC/Carbon/EPDM	○	○	○	○	○	○	○	○	○	○	○	○
		SiC+Graphite/SiC/EPDM	○	○	○	○	○	○	○	○	○	○	○	○
	O-ring	FPM	●	●	●	●	●	●	●	●	●	●	●	●
		EPDM	○	○	○	○	○	○	○	○	○	○	○	○
	Outer casing	AISI 304 (EN 1.4301)					AISI 316L (EN 1.4404)							
Motor bracket	Cast Iron													
Tie rod	AISI 431 (EN 1.4057)													
Coupling	up to 5 HP	Die cast aluminium												
	from 7 1/2 HP	Cast Iron												
Base	Die cast aluminium													
Pipe connection	Oval flange	up to 230 PSI	○	○	○	○	○	○	○	○	○	○	○	
	Round flange (ANSI compatible raised face)	up to 230 PSI	●	●	●	●	●	●	●	●	●	●	●	
		from 230 PSI to 375 PSI	●	●	●	●	●	●	●	●	●	●	●	
	Loose round flange (ANSI compatible raised face)	up to 230 PSI	○	○	○	○	○	○	○	○	○	○	○	
		from 230 PSI to 375 PSI	○	○	○	○	○	○	○	○	○	○	○	
Victaulic	up to 230/375 PSI	○	○	○	○	○	○	○	○	○	○	○		
Motor	Type	NEMA C/TC/TSC frame, TEFC or ODP enclosure												
	Speed	2-or 4-pole, 60 Hz, 3500 or 1750 rpm nominal speed												
	Power Requirements	3 Phase, 230/460V or 208-230/460V - Single Phase, 115/230V												
	Direction of Rotation	Clockwise when viewed from motor end												
	Motor Options	Consult factory for optional motor types												

Legend: ● Standard ○ Options

# Product Specifications

EVMSU(L)N 3-5-10  
Low NPSH

PUMP								
Version		EVMSUN			EVMSULN			
<b>Performance range</b>	Nominal size	3	5	10	3	5	10	
	Motor Power	3/4 to 15 HP						
	Capacity	6.6 to 79.26 US gpm						
	Total Head	54 to 815 ft						
<b>Liquid Handling</b>	Type of liquid	Clean water <i>(for other clean liquids, consult factory)</i>						
	Maximum working pressure	360 psi						
	Liquid temperature range	-22°F to 284°F (-30°C to 140°C)						
<b>Pipe Connection</b>	Suction size	1 1/4"	2"		1 1/4"	2"		
	Discharge size	1 1/4"	2"		1 1/4"	2"		
	Flange type	Round flange (ANSI compatible raised face)						
<b>Key Component Materials</b>	Impeller	AISI 304 (EN 1.4301)			AISI 316 (EN 1.4401)			
	Intermediate casing	AISI 304 (EN 1.4301)			AISI 316 (EN 1.4401)			
	Liner ring	AISI 304 (EN 1.4301) + PPS			AISI 316 (EN 1.4401) + PPS			
	Bottom casing	AISI 304 (EN 1.4301)			AISI 316 (EN 1.4401)			
	Casing cover	AISI 304 (EN 1.4301)			AISI 316 (EN 1.4401)			
	Shaft	AISI 304 (EN 1.4301)	EVMSUN 3-5-10 (depending on model)					
		AISI 316L (EN 1.4404)	EVMSULN 3-5-10 (depending on model)					
		AISI 329A (EN 1.4462)	EVMSUN / EVMSULN 5 (depending on model)					
	Shaft sleeve bearing	Tungsten carbide						
	Shaft Seal	SiC+Graphite/SiC/EPDM						
	O-ring	EPDM						
	Outer casing	AISI 304 (EN 1.4301)			AISI 316L (EN 1.4404)			
	Motor bracket	Cast Iron						
	Tie rod	AISI 431 (EN 1.4057)						
	Coupling	up to 3 HP	Die cast aluminium					
from 5 HP		Cast Iron						
Base	Die cast aluminium							
<b>Motor</b>	Type	NEMA C/TC/TSC frame, TEFC or ODP enclosure						
	Speed	2-pole, 60 Hz, 3500 rpm nominal speed						
	Power Requirements	3 Phase, 230/460V or 208-230/460V - Single Phase, 115/230V						
	Direction of Rotation	Clockwise when viewed from motor end						
	Motor Options	<i>Consult factory for optional motor types</i>						

# Sectional Drawing

EVMSU(G)(L) 32-90

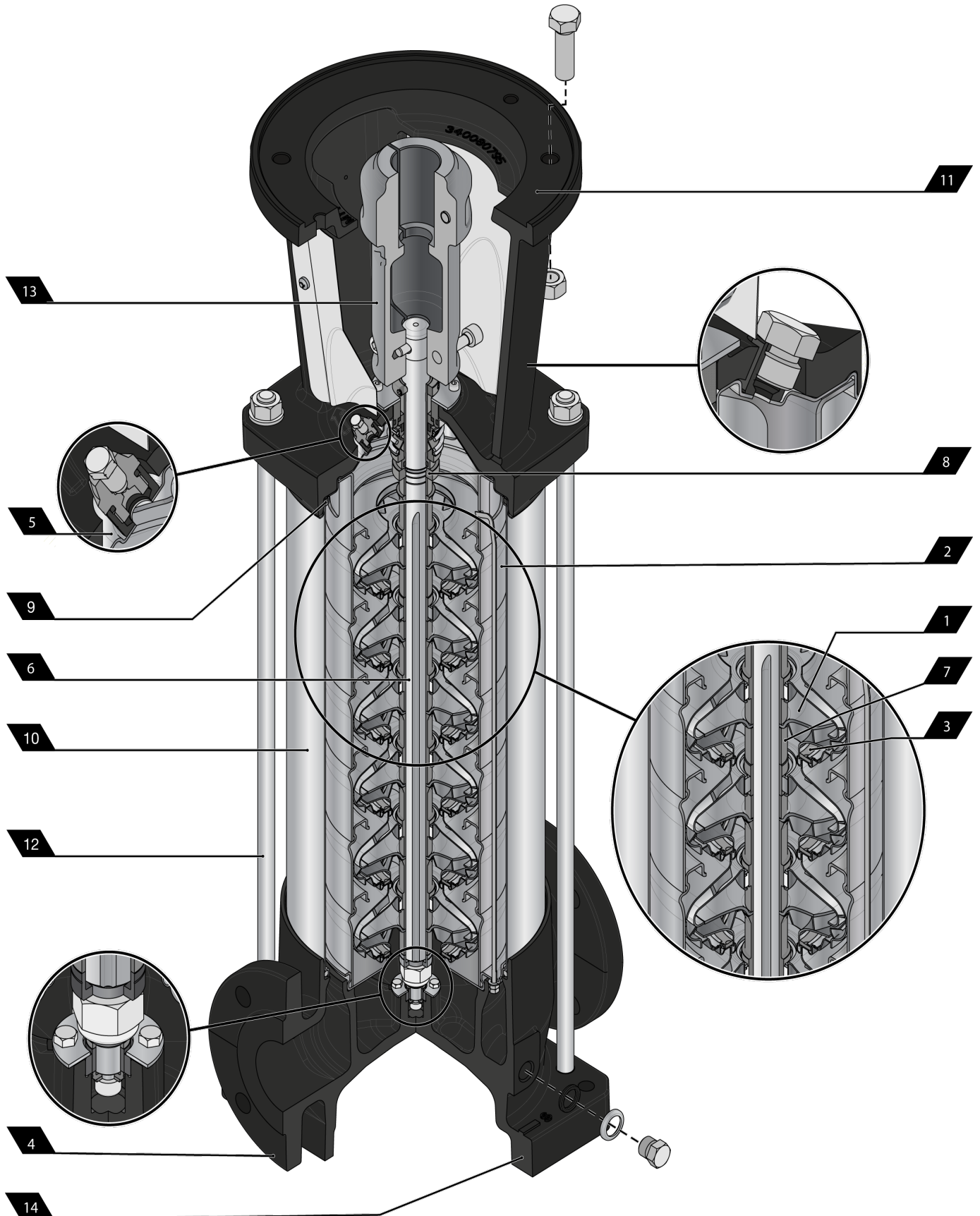

# Product Specifications

EVMSU(G)(L) 32-90

PUMP															
		EVMSUG				EVMSU				EVMSUL					
Performance Range	Nominal size	32	45	64	90	32	45	64	90	32	45	64	90		
	Motor Power	5 to 60 HP													
	Capacity	79.3 to 607 US gpm													
	Total Head	20.7 to 918.7 ft													
Liquid Handling	Type of liquid	Clean water (for other clean liquids, consult factory)													
	Maximum working pressure	230 / 360 / 435 psi (depending on model)													
	Liquid temperature range	-22°F to 248°F (-30°C to 120°C)													
Size	Suction	2 1/2"	3"	4"	4"	2 1/2"	3"	4"	4"	2 1/2"	3"	4"	4"		
	Discharge	2 1/2"	3"	4"	4"	2 1/2"	3"	4"	4"	2 1/2"	3"	4"	4"		
Key Component Materials	1	Impeller	EN 1.4301 (AISI 304)								EN 1.4404 (AISI 316L)				
	2	Intermediate casing	EN 1.4301 (AISI 304)								EN 1.4404 (AISI 316L)				
	3	Liner ring	EN 1.4301 (AISI 304) + PPS								EN 1.4404 (AISI 316L) + PPS				
	4	Bottom casing	EVMSU(G)32	Cast Iron EN GJL-250 EN 1561				EN 1.4308 (ASTM CF8)				EN 1.4408 (ASTM CF8M)			
			EVMSU(G)45-64-90 230 psi	Cast Iron EN GJS 400-15 EN 1563											
			EVMSU(G)45-64-90 230+ psi												
	5	Casing cover	EN 1.4301 (AISI 304)								EN 1.4404 (AISI 316L)				
	6	Shaft	AISI 304 (EN 1.4301)								AISI 316L (EN 1.4404) (Depending on model)				
											AISI 329A (EN 1.4462) (Depending on model)				
	7	Shaft sleeve bearing	Tungsten carbide												
	8	Shaft Seal	SiC/Carbon/FPM	●	●	●	●	●	●	●	●	●	●	●	●
			SiC+Graphite/SiC/FPM	○	○	○	○	○	○	○	○	○	○	○	○
			SiC+Graphite/SiC/EPDM	○	○	○	○	○	○	○	○	○	○	○	○
	9	O-ring	FPM	●	●	●	●	●	●	●	●	●	●	●	●
EPDM			○	○	○	○	○	○	○	○	○	○	○	○	
10	Outer casing	EN 1.4301 (AISI 304)								EN 1.4404 (AISI 316L)					
11	Motor Bracket	Cast Iron EN GJS 400-15 EN 1563													
12	Tie rod	EN 1.4057 (AISI 431)													
13	Coupling	up to 5 HP	Die cast Aluminium EN AB-AISI11 Cu2 (Fe)												
		from 7 1/2 to 40 HP	Cast Iron EN GJL250 EN 1561												
		50 HP and larger	Carbon Steel												
14	Base	Cast Iron EN GJL200 EN 1561													
Pipe connection	Round flange (ANSI compatible raised face)	●	●	●	●										
	Loose round flange (ANSI compatible raised face)					●	●	●	●	●	●	●	●		
Motor	Type	NEMA C/TC/TSC frame, TEFC or ODP enclosure													
	Speed	2-pole, 60 Hz, 3500/3550 rpm nominal speed													
	Power Requirements	3 Phase, 230/460V or 208-230/460V - Single Phase, 115/230V													
	Direction of Rotation	Clockwise when viewed from motor end													
	Motor Options	Consult factory for optional motor types													

● Standard ○ Optional



Your Local EBARA representative: \_\_\_\_\_

**ENGINEERED**for**PERFORMANCE**

**EBARA Pumps Americas Corporation**

1651 Cedar Line Drive, Rock Hill, SC 29730  
t (803) 327-5005 | f (803) 327-5097

**[www.pumpsebara.com](http://www.pumpsebara.com)**

All specifications subject to change without notice.  
©2018 EBARA Pumps Americas Corporation, All rights reserved. rev. 1123